

BUYDEEM

K2763

BUYDEEM Beverage Maker

Instruction Manual



BUYDEEM

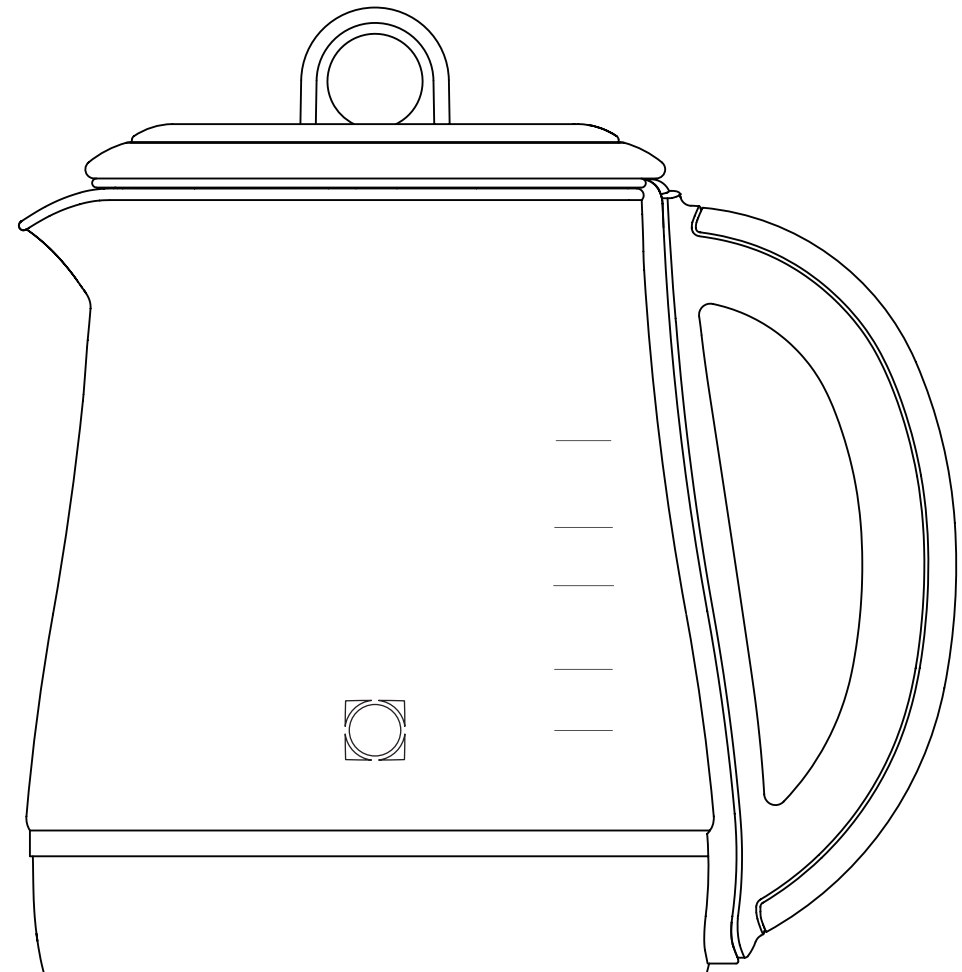

Shenzhen Crastal Technology Co.,LTD

Block 7&8, D Industrial Zone, Buchong, Shajing, Bao' an,
Shenzhen City, Guangdong province P.R.China

K2763-91-A2

If the product is slightly modified, please refer to the actual product
Please read this manual carefully before using this product,
and please keep it in a safe place.

Thank you for purchasing BUYDEEM products. In order to allow you to fully enjoy BUYDEEM full support, please read this manual and related illustrations in detail before using this product.

Contents

Notice	02	Use product	12 ~ 18
Technical specifications	03	Initial use	12
Knowing the product	04 ~ 11	User Guide	13
Product structure drawing	04	Boiling point detection	19
Function mode introduction	05	Features	22
Part Introduction	07	Cleaning and maintenance	23
		Simple troubleshooting	24
		Environmental checklist	25
		Warranty and service	26

Notice

Danger

- Do not operate this product unattended to prevent fire and other dangers caused by unexpected situations.
- To prevent the risk of electric shock or short circuit, do not put the beverage maker, base, power cord and plug in water or any other liquid.

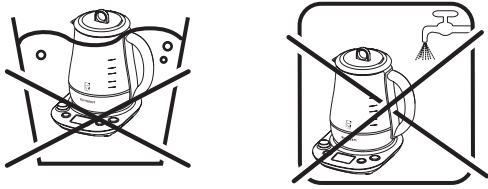

Warning

- Children, the elderly, people with limited physical or mental abilities, and those without experience should use the product under supervision and guidance and ensure its safety. Children should be exposed to this product under supervision to ensure that they will not play with the product as a toy.
- This product must be used alone with a grounding socket with a rated current of more than 10A and a rated voltage of 120V, 60Hz. The plug must be fully inserted into the socket to prevent overheating of the components due to poor contact, resulting in short circuit or fire hazards. Do not use a universal socket.
- Keep the beverage maker and power cord away from high temperatures, open flames, damp, smooth surfaces or sharp edges to prevent damage to the device, failure or fire.
- It is forbidden to use beverage maker when hands are wet with water or bare feet.

Attention

- This product is designed for home use only, and the manufacturer only guarantees production defects and household faults; the manufacturer is not responsible for any consequences or faults caused by any commercial use, unsuitable use, or failure to follow the instructions, and these faults are damaged that none are covered by the warranty.
- Before using, please check whether the voltage displayed on the product specification label is consistent with the main voltage.
- This product must be used with its supporting base, do not use other bases.
- Please always place the beverage maker on a flat, stable and heat-resistant workbench.
- Before using the product, please make sure that the upper cover is properly closed to prevent burns.
- The beverage maker will generate high temperature and steam during work. Please do not open the pot lid, touch or move the beverage maker, near the steam outlet and other high temperature parts during work to prevent burns.
- Do not place and heat the product on the closed container inside, avoid the explosion risk.
- Do not run the beverage maker when it exceeds the maximum water level or below the minimum water level; the water or ingredients in the health pot are too full, which may cause boiling water to splash out.
- The beverage maker should be protected from moisture and freezing. Do not put the beverage maker in the refrigerator.

Notice

Attention

- To prevent electric shock or fire, please ensure that the power supply is disconnected in the following cases: when the pot is empty, when the beverage maker is not used, when the beverage maker is cleaned or moved, when the beverage maker parts are damaged, and when the beverage maker malfunctions.
- If the beverage maker is not used for a long time, it is recommended to drain the water in the beverage maker.
- If you need to pull out the plug, please hold the plug and pull it out. Do not pull or twist the power cord forcibly to prevent damage to the power cord and the risk of electric leakage.
- Please do not let the power cord hang outside the edge of the table or work surface to prevent the beverage maker from falling or causing a trip.
- Please do not use non-recommended methods to remove scale. Refer to P23 for recommended methods.
- To avoid scratches on the display, wipe the surface with a soft cloth.
- Recommend to use pure water for cooking. If the heating plate fails due to excessive scale, please clean the scale on the heating element regularly.
- If you find that the beverage maker parts are damaged or not working properly, please unplug the power plug immediately. Do not continue to use it or dismantle it by yourself. Please go to the service centre authorized by BUYDEEM for replacement or repair.
- In addition to cleaning and descaling according to the instructions, any abnormal operation must be performed by a service centre authorized by BUYDEEM.
- If the beverage maker is not descaled, it cannot be used normally or cannot be used at all, which is not covered by the warranty.
- Because all products are strictly in accordance with quality control procedures, including the actual use testing of randomly selected products, they will explain any traces of use of the products.
- If the power cord is damaged, in order to avoid danger, it must be replaced by the personnel of BUYDEEM after-sales maintenance department.

technical specifications

Product Name	BUYDEEM Beverage Maker		Model	K2763	
Product power	1000W	Maximum capacity	1.5L	Voltage	120V, 60Hz.

Food grade material including SUS316 and 304 stainless steel, Glass(German Schott), Polypropylene PP plastic, Silicone for food contact.

Understanding Product

Product Structure

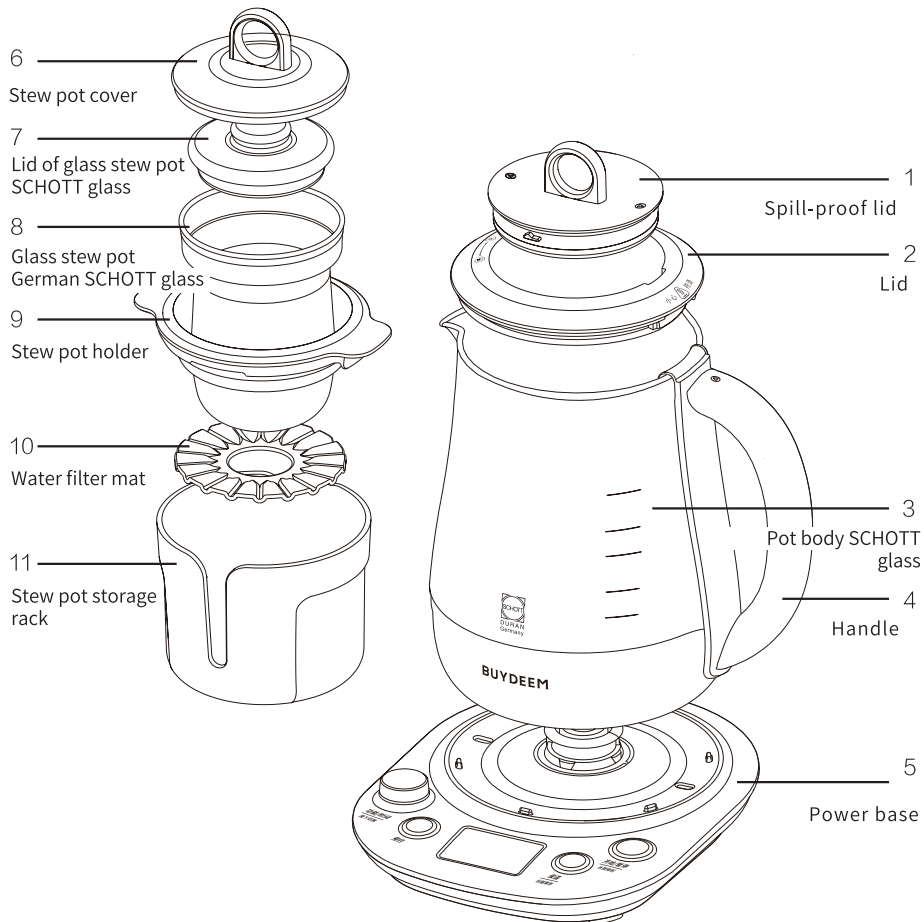

Understanding Product

Function introduction

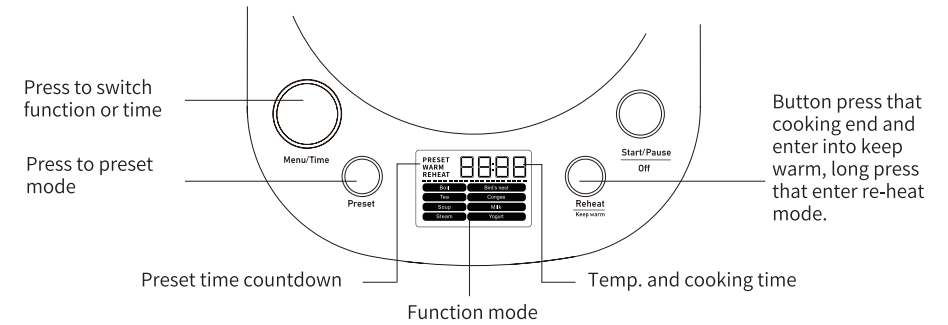

Function Type	Name	Time or Temp. Range (Knob)	Operation Mode	Keep warm (Manual Start)
Basic functions	Boiling water	Six temperature adjust: 40/50/60/70/85/100 °C	Quickly boil water to the target temperature and stop. Note: Please do not use this function to heat soup / liquid except water, otherwise overflow may occur.	Keep warm at 70 °C after boiling, keep at other temperature for 2H.
	Keep warm / Long press to reheat (70 °C / 2H).	/	1.Short press to enter keep warm after cooking end. 2.Long press to enter reheat mode directly. When water temperature is lower than 70 °C, heat water to 70 °C and automatically keep warm for 2H; if the water temperature is higher than 70 °C, enter keep warm directly. Ps: Reheat mode cannot be entered in preset or cooking mode.	70°C, 2H
Cooking	Soup (default 1H)	30min~2.5H	After boiling water, soup mode work for 1H, enter keep warm mode manually.	70°C, 2H
	Tea (default 10min)	5~20min	After boiling water, tea mode work for 10min, enter keep warm mode manually.	70°C, 2H

Understanding Product

Function Type	Name	Time or Temp. Range (Knob)	Operation Mode	Keep warm (Manual Start)
Stew mode (use with stew pot)	Bird's nest (default 30min)	20~45min	After boiling water, bird's nest mode work for 30min, enter keep warm mode manually.	70 °C, 2H
	Congee (default 1H)	30min~2H	After boiling water, congeemode work for 1H, enter keep warm mode manually.	70 °C, 2H
	Yogurt (default 8H/40°C)	8~9.5H	Heat the water in pot to 40 °C, keep this temperature in yogurt mode for 8 hours. If temperature of water in pot is too high, whenselect "yoghurt" mode, the display shows E1, beverage maker will automatically stop after the alarm sounds.	/
	Milk (default 10min /60 °C)	5~20min	Heat the water in pot to 60 °C, milkmode work for 10min, no keep warm mode.	/
Steaming mode (use with steamer)	Steaming (default 15min)	5min~1H	After boiling water, steamingmode work for 15min, enter keep warm mode manually.	70 °C, 2H
Preset	Preset	30min~18H	Pressthis button to enter preset mode. Based on preset time setting, after time countdown, it will enter the selected cooking mode automatically. Tip: If in preset mode, the displayed preset time does not include the cooking time.	/
Others	Start/Pause	/	Press this button to start / pause product. Press and hold for 2 seconds to enter the standby state.	/

Note!

1. Must use K2763 beverage maker body and K2763 power base. Do not mix other brands of beverage maker or other models of BUYDEEM beverage maker with K2763. Otherwise, it may not be able to be used normally and there may even be dangers of short circuit and electric shock.
2. The above cooking time starts after water is boiled, not include water boiling time.

Understanding Product

Component design

Spill-proof liddesign

- In accordance with the daily usage habits of users, a unique design of two spill-proof lidnested with each other is added.
- When the Beverage maker is working normally, the user can unscrew the spill-proof lidat any time to observe the food cooking status, so as to choose various operations such as addition or seasoning.
- If excessive foam is generated during food cooking, it is recommended to open the spill-proof lidto prevent spillage.

1. Installation of spill-proof lid:

- Hold the handle against the lid and turn clockwise to tighten.

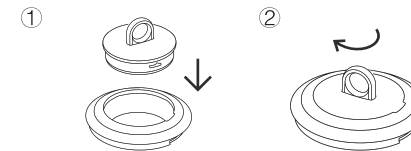

2. Removal of spill-proof lid:

- Hold the handle against the lid and turn counterclockwise to unscrew.

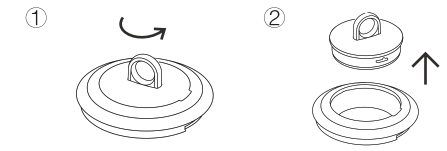

Understanding Product

Introduction to Glass stew pot

⚠️Note:

- Do not pour water after installing the stew pot in the beverage maker to prevent the risk of burns caused by the stew pot and the bracket falling.
- Do not directly heat the glass stew pot.
- Do not put the glass stew pot in the oven or microwave to heat it.
- The effective maximum capacity of the stew pot is 500ml (about 70% of the height of the stew pot), please do not exceed the maximum capacity when using it, so as to avoid burns caused by the overflowing of ingredients during use.

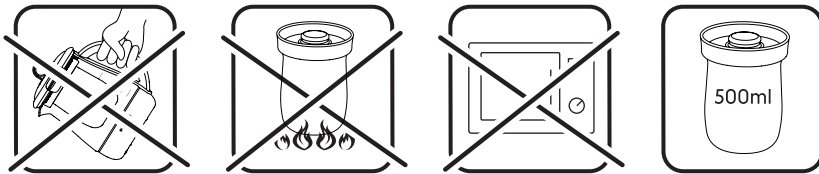

1. Glass stew pot installation:

- Place the stew pot in the rack;
- Lift the stand together with the stew pot;
- Install on the beverage maker and cover it with a large lid. Pay attention to align the triangle mark of the bracket with the triangle mark of the pot handle.

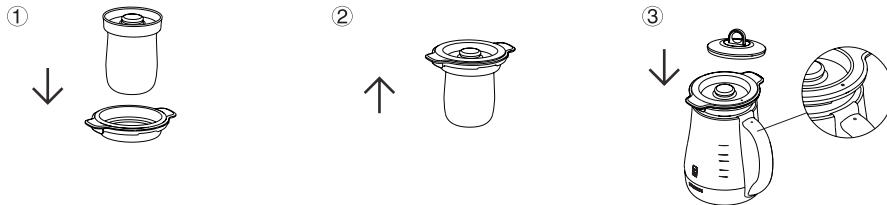

2. Disassembly of glass stew pot:

- Lift the stand and take out the stew pot together;
- Gently lower the stand;
- Remove the lid of the stand and take out the stew pot.

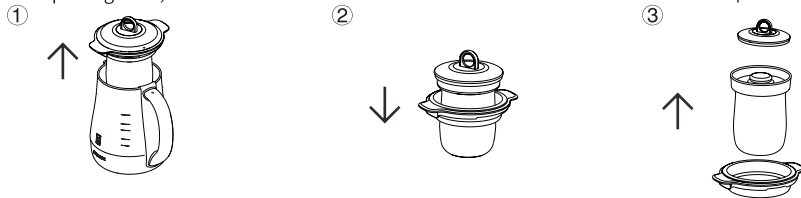

Understanding Product

Stew pot storage design

- In order to facilitate users to store and dry the stew pot, the unique design of the stew pot storage rack is added to the beverage maker.
- The user can put the stew pot in the storage rack to dry after using it; after drying, the stew pot can be placed in the storage rack for storage.

1. Dry the stew pot:

- After washing the stew pot, first put the glass inner cover into the storage rack;

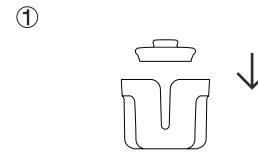

- Put down the stew pot bracket and the stew inner cover in turn;

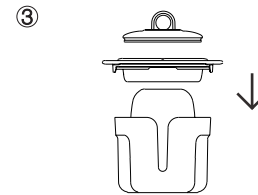

2. Storage stew pot:

- Put the stew pot into the rack;

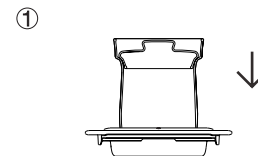

- Inverted glass stew pot;

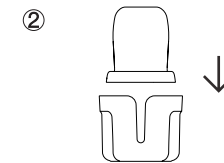

- Place the stew pot and stew stand as shown in the picture until dry.

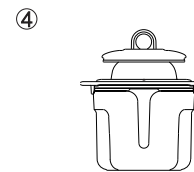

- Put the rack and stew pot together into the storage rack, and then put into the rack cover.

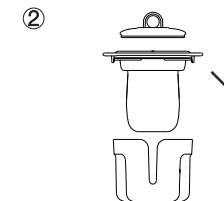

Understanding Product

Steamer design

- The steamer is not included in the product standard and must be purchased separately.
- This product must be used with BUYDEEM beverage maker. Select the steaming function when using, and the water volume in the pot should be controlled between 750ml and 1500ml to avoid accidents such as dry burning or overflowing the pot.
 - Due to the nature of the food or the adhesion of dirt, it is easier to deposit the dirt on the bottom of the beverage maker when using the steaming function, causing scale or stains. It is recommended to use pure water for cooking and clean the heating plate regularly. Refer to P23 for cleaning to prevent the heating plate from malfunctioning due to excessive scale.
- When opening the upper cover, please pay attention to steam to prevent burns.
- Do not use the steaming function while cooking food in the pot.
- Do not cover the steam port with cloth, etc., to avoid accidents or damage to the product.
- Do not heat directly with an open flame or put it in a microwave oven or oven.
- During use, be sure to move the cage body and lid within the range of the anti-scald handle, and pay attention to steam to avoid the risk of burns, slipping, etc.
 - When using, please make sure that the bottom hole in the cage is not blocked to prevent steam from entering the steamer and affecting the cooking effect.

1. Steamer installation:

- Place the steamer above the beverage maker;
- Just align the filter port and the handle and put it in.

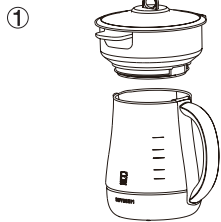

2. Steamer disassembly:

- Take the steamer handle with both hands and take out the steamer. Pay attention to the steam to avoid scalding;
- Place the steamer on a flat surface.

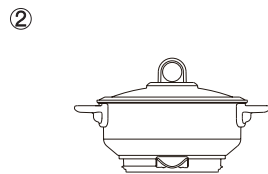

Understanding Product

Filter tea basket design

- The filter tea basket is not included in the product standard and must be purchased separately.
- In order to facilitate users to filter inedible ingredients / tea leaves, the unique design of the beverage maker is added with a handle-type tea basket.
- During the cooking process, users can put inedible ingredients into the tea basket; if they are concerned about the strong taste, they can open the tea basket cover during the cooking process and remove the tea basket.

1. Filter tea basket installation:

- Grasp the handle of the tea basket and put the tea basket into the hollow part of the lid;
- Tighten the tea basket cover clockwise. When a slight "tick" sound is heard, it means it has been tightened;
- Put the entire lid into the beverage maker and install it on the mouth of the pot, align the strainer with the spout, and press gently to make the pot lid tight.

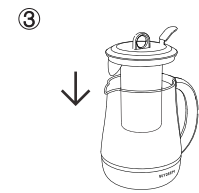
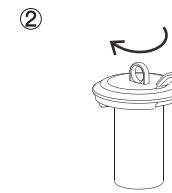
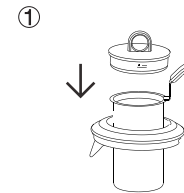

2. Disassembly of filter tea basket:

- Unscrew the tea basket cover counterclockwise;
- Grasp the tea basket handle and raise the tea basket.

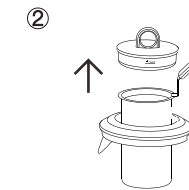
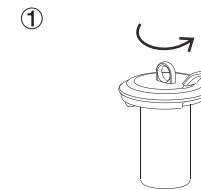

Tea-cup design

- In order to facilitate the user to place and store the tea basket, the unique design of the tea pot is added to the beverage maker.
- When the tea basket is taken out from the beverage maker, it can be placed in the cup to prevent the tea basket from dripping water to the table.

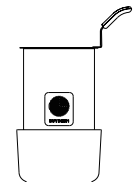

Using Product

Initial use

1. Remove all packaging, labels and accessories from inside and outside the beverage maker. Before using the product for the first time, we recommend that you do a boiling point test (see P 19 for details).

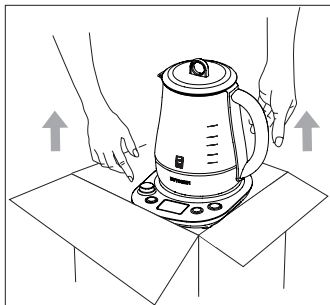

2. The first 2-3 times of boiling water should be poured out for cleaning, and then wipe the outside of the health pot parts with a damp cloth (please note that the electrical connectors on the bottom and base of the pot should not touch the water).

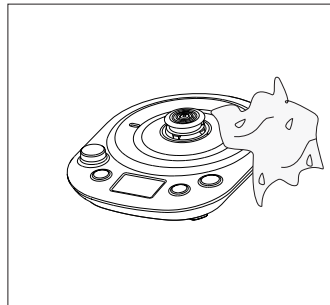

Fast installation

1. Adjust the length of the power cord through the winding device of the base.

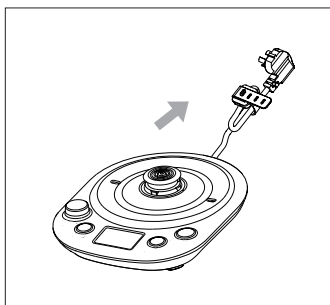

2. Place the beverage maker on the base.

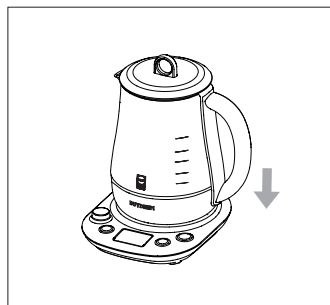

Using Product

Guidelines for users Cooking function

1. Open the lid

- Tighten the handle of the spill-proof lid, and pull upward to remove the lid



2. Add ingredients



3. Add appropriate amount of purified water

- Do not add water when the beverage maker is on the base.
- Do not add water and ingredients above the maximum water level or below the minimum water level.
- If the water is too full, water may splash when boiling.
- Please note that it is recommended to add water to the water level of 1200ml for ingredients that are easy to foam, such as white fungus, astragalus, black tea, etc. Just use the line and open the lid of the spill-proof lid while cooking.



4. Close the lid tightly

- Place the lid on the pot as shown in the figure. Make sure the spout filter is aligned with the spout. Press lightly to make the lid tightly closed. Lift it gently with your hand. If it cannot be lifted, it means the lid is tightly closed.
- If the cover is not assembled properly, the cover will fall off easily when pouring water.



Using Product



5. Place the beverage maker on the base

- Please wipe the water on the bottom and base of the pot.
- The base must be placed on a flat, clean heat-resistant table.
- The body of the beverage maker must use an exclusive base.
- Do not use when there is no water in the beverage maker.

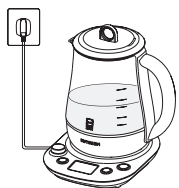

6. Plug in the power

- When the beverage maker is powered on, the buzzer sounds, and the button light flashes after the light is off, indicating that it enters the standby state and can start to select functions.

Stew function



1. Add ingredients to the glass Stew function

- Put the food into the stew pot, add the appropriate amount of water, and install the stew pot as shown in P8.



2. Add appropriate amount of purified water

- Add water to the scale of the beverage maker 1000m (l water level before the cup).
- Do not add water when the beverage maker is on the base.

Using Product

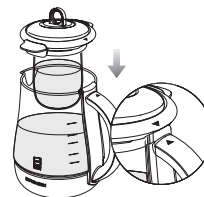

3. Install the lid

- Lift the stand with the stew pot and install it on the beverage maker.
- Please note! Please make sure that the triangle mark on the bracket is aligned with the triangle mark on the handle of the beverage maker body, otherwise the stew pot The bracket is not installed properly.



4. Place the beverage maker on the base

- Please wipe the water on the bottom and base of the beverage maker.
- The base must be placed on a flat, clean heat-resistant table.
- The body of the beverage maker must use an exclusive base.
- Do not use when there is no water in the beverage maker.

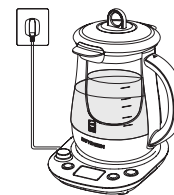

5. Plug in the power

- When the beverage maker is powered on, the buzzer sounds, and the button light flashes and the light goes out, indicating that it has entered the standby state and can start selecting functions.

Using Product

Function mode usage guidelines

step 1: Function selection.

Use the knob to rotate left and right to select any cooking function mode. The button of the selected function will be flashing, and the default duration of the current function will appear at the upper right of the screen. Like tea mode, it is cooked for 10 minutes by default.

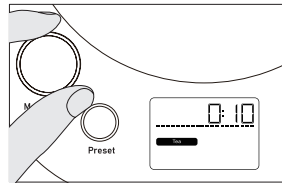

step 2: Temperature / time adjustment.

In boil mode, press the knob to enter the boiling water temperature adjustment interface. In other function modes, press the knob to enter the cooking time adjustment interface. If you choose tea mode, turn the knob to adjust the cooking time to 15 minutes. If you do not need to adjust the boiling water temperature or cooking time, you can skip to step3 directly.

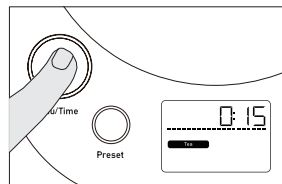

step 3: Confirm the function and start.

Press the "Start / Pause" button to enter the cooking phase.

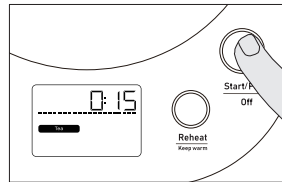

step 4: Cooking process.

When the cooking starts, the display shows in stages, taking tea mode as an example, they are:

1. The machine first heats the pot water to the specified temperature, the display shows the pot water temperature at that time

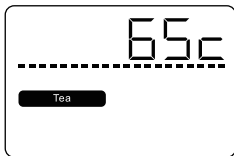

2. When entering the low fire frequency conversion and slow cooking, the specified temperature is displayed, and the display shows the current pot cooking time countdown

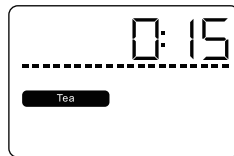

3. After the cooking is completed, if the keep warm mode is turned on, the keep warm mode countdown is displayed

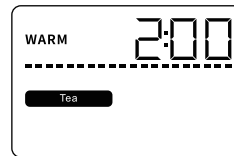

Tip: If it is boil mode, the display always shows the current pot water temperature, and does not display the countdown.

Using Product

Guidelines for using the keep warmfunction

When you select any function, press the "keep warm" button, the light circle will light up, and the machine will automatically enter 70 ° C after the function is completed, and keep warm for 2 hours.

Tip: Due to the particularity of the ingredients, the "Yogurt" and "milk" functions cannot be turned on for automatic keep warm.

Long press Reheat function user guide

step 1: Press and hold the "reheat" button for 2 seconds, the screen will display "heating" and "70 ° C".

Note: The reheat function cannot be entered in preset and cooking modes.

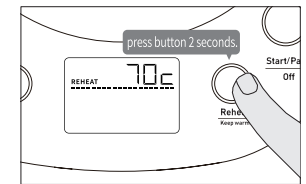

step 2: Press the "Start / Pause" button, the machine starts the reheat function. That is, heat the soup to 70 ° C for 2 hours.

Tip: Stir the soup before starting the reheat function to prevent the ingredients from sinking and bottoming.

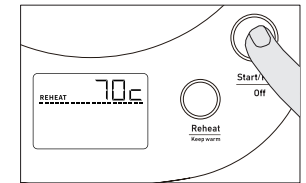

Using Product

Guidelines for using the preset function

step 1: Preparation for preset.

Press the "preset" button to enter the preset time selection interface, you can use the knob to adjust the preset time. If you choose the soup mode for 1H, make an appointment for 8H.

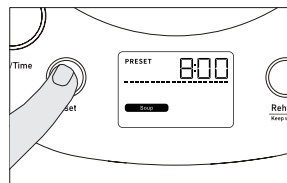

step 2: preset modification

In the preset preparation stage, you can press the knob at any time to switch between the three major interfaces: preset time-function selection-cooking time. The current interface flashes, and any function or time can be adjusted by turning the knob.

step 3: Confirm the preset.

After selecting the preset time, function and cooking duration, press the "Start / Pause" button to enter the countdown. The progress light runs.

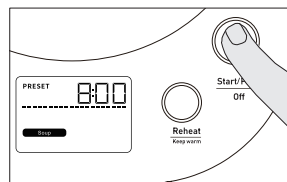

step 4: The preset is cancelled or suspended.

If you are in the preset preparation stage, you can press the "preset" button at any time to exit the preset mode; if you have entered the preset countdown, you can first press the "Start / Pause" button, press the button to pause the program, then press the "preset" button to cancel Make an appointment and exit the appointment interface.

Reminder: Due to the particularity of the ingredients, there is no preset mode for the "Yogurt" and "milk" functions.

Boiling point detection

Boiling point detection memory program

- Because in non-zero altitude areas, the water cannot reach 100 °C when boiling, which will cause the normal beverage maker to not work properly (the trip is too slow or even normal trip).
- BUYDEEM recommends that you perform a boiling point detection operation for the first time. After the test is completed, the chip will record the accurate boiling point data and use it again without repeating the test.
 - After the boiling point detection, the beverage maker can work more accurately (the performance is better than the factory setting).
 - If you are in a city with an altitude higher than 250m, be sure to perform boiling point detection before use.

Start boiling point detection

1. Add water to the 1200ml water level line. If the amount of water is insufficient or excessive, it will affect the test results.
2. Put in the wire base and do not power on first



Boiling point detection

3. Simultaneously press and hold the "keep warm" and "Start / Pause" buttons, press firmly, and then insert the power plug into the power supply. After hearing a short beep, the screen displays "H1", and then you can release your finger.

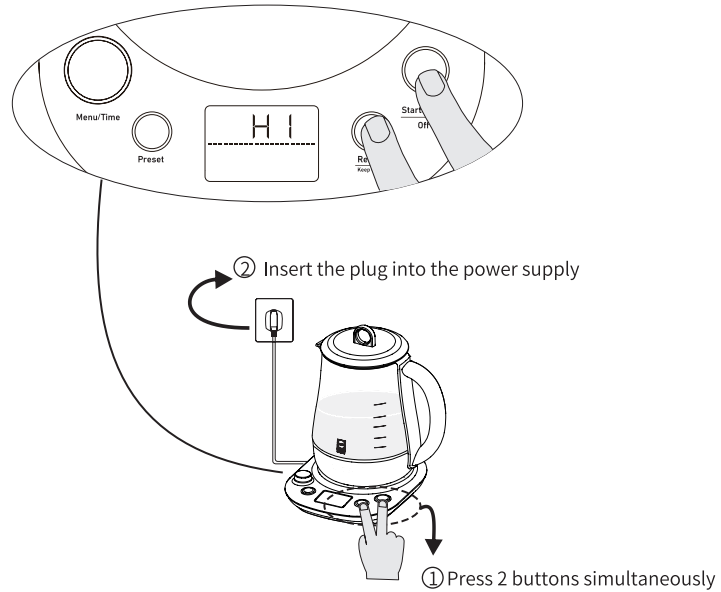

4. "Start / Pause" light circle flashes, click "Start / Pause" to start detection. After starting the test, the screen continues to display "H1" while the progress bar runs. After the detection is completed, a shutdown sound will sound, and the work will be automatically ended and enter the standby state.

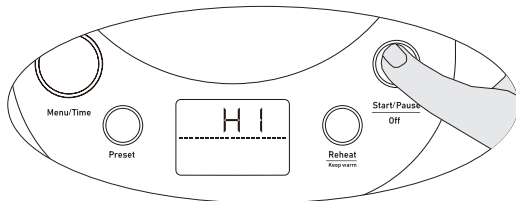

Boiling point detection

Factory reset of boiling point

The machine has the function of boiling point restoration to factory settings. The key lamp is displayed once in a cycle, then the shutdown sound sounds, and it automatically enters the sleep mode, and the boiling point is restored to the factory setting of 100 ° C.

Simultaneously hold down the knob and the "reservation" button, insert the power plug, and keep pressing the button for 2 seconds, the machine enters the boiling point recovery factory setting mode, at this time, the 4 button lights are displayed once, then the shutdown sound will automatically enter the sleep mode, and the boiling point recovery The factory setting is 100 ° C.

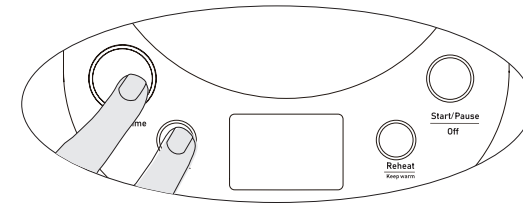

Features

Beverage maker pause memory function

When the beverage maker works according to the program, it can be suspended by lifting the pot or pressing "Start / Pause". Within 1 hour, the pot will be started by placing the pot or pressing "Start / Pause". The beverage maker will perform a pause before the unfinished program time, the function program will not be executed again.

Avoid misuse

Within 1 minute of the start of the beverage maker, you can press the knob to switch the mode at will. After switching the mode or time, press the "Start / Pause" button again to enter the cooking state. In order to avoid mis-operation, the function cannot be switched at will after the health pot starts working for 1 minute. If you need to switch functions, you need to press the "Start / Pause" button first, then "Start / Pause" button flashes and select the program to be switched.

Cold water protection

When the beverage maker is working, if you add cold water in the middle of cooking, the health pot will automatically boil the water and then perform the unfinished program, without worrying about the hidden danger of cold.

Cleaning & Maintaining

Cleaning & Maintenance

Cleaning of beverage maker

1. Unplug the power plug.
2. After the kettle cools, clean the inside of the beverage maker with a wet sponge.
Note: Do not immerse the beverage maker, base, power cord or plug in water (the bottom of the pot and the electronic connectors on the base must not touch water).
3. After each use, in order to avoid food deterioration, please clean it in time.

Display maintenance

To avoid scratches and damage to the display, wipe the surface gently with a soft, dry cloth.

Descaling

The beverage maker needs to be descaled regularly, at least once a month, and the number should be increased if the water quality is poor. If there are spots on the heating plate, this is scale, which is a normal phenomenon. It can be cleaned by scrubbing with a scouring pad. If the situation is more serious, the following methods can be used for descaling.

Tips for descaling of beverage maker

Use white vinegar:

- Add 100ml of white vinegar to the beverage maker.
- Fill the beverage maker with water to the 500ml mark.
- Activate the "water boiling" mode.
- After the procedure, let it stand for 1 hour, then wipe the bottom of the pot with a scouring pad.

Use citric acid:

- Add 500ml of water to the beverage maker.
- Add 10g of citric acid.
- Activate the "boil water" mode.
- After automatic power off, let stand for 5-10 minutes. (If there is a lot of scale, you can extend the standing time)
- Finally, pour out the water in the pot and wipe the bottom of the pot with a scouring pad.

Simple Troubleshooting

Simple troubleshooting

Failure phenomenon	Cause analysis	Troubleshooting
After installation, there is no prompt sound and the button light is off	No power supply	check if the socket is plugged in
	The pot and the base are not connected in place	after the pot is placed on the line base, you can rotate or adjust the position to confirm that it is connected in place
	Wire seat failure	suggest forsendng to service point for repair
The beep sounds continuously	Dry burn protection (general button lights are on)	after cooling for a few minutes, pour cold water to continue to use
	NTC abnormal	it is recommended to send to the service point for repair
The pot stops working after heating for 10 seconds, and it will automatically shut down after 3 short beeps	Tips for high temperature of water in the pot	generally this situation will occur in functions such as heat preservation, yogurt, warm milk, etc. The water temperature in the pot is higher than the temperature set by the program, add cold water and continue to work
Water smells	Unused new beverage maker	it is recommended to boil the water several times before use. If the situation persists, fill the water to the highest level and add two teaspoons of soda. After boiling, pour out and clean the beverage maker

Correspondence table of display fault codes

Display code	cause of issue	solution
E1	Over temperature warning	use pure water below target temperature
E2	dry roasting	after cooling for a few minutes, pour cold water and continue to use
E3	The pot body and the base model are inconsistent	use the same type of pot body and base

List of Environmental Protection

The names and contents of poisonous and hazardous substances or elements in the product

Parts name	Hazardous substance					
	Plumbum (Pb)	Mercury (Hg)	Cadmium (Cd)	Chromium VI (Cr (VI))	polybrominated biphenyls (PBB)	polybrominated diphenyl ethers (PBDE)
Kettle lid components	○	○	○	○	○	○
Kettle body components	○	○	○	○	○	○
Base components	○	○	○	○	○	○
Heating plate components	×	○	×	○	○	○
Circuit board components	×	○	○	○	×	×
Power cord	×	○	○	○	○	×

○: Means the content of hazardous substance in all homogeneous materials of the component is below the limit specified in GB/T 26572.

×: Means that the content of the toxic and hazardous substances at least in a homogeneous material of the component exceeds the limit specified in GB/T 26572.

	<p>Environment-friendly use period of 10 years: Means the hazardous substances contained in the product will not be leaked or mutated, and the normal use of product by user under the circumstances described in the product manual will not cause serious pollution to the environment or cause serious damage to the person or property of the user.</p> <p>Arrow circulation mark: Means the product can be recycled. It should not be thrown away at will after exceeding the service life or being unable to work properly after maintenance. Please send to the formal recycling channels and enterprises with the qualification of disposing waste electrical and electronic products for treatment. For the correct treatment method, please refer to the national or local regulations on the disposal of old electrical and electronic products.</p>
--	---

The above marks shall be implemented according to the administrative measures for restricting the use of hazardous substances in China and the supporting standards SJ/T 11364.

Warranty & Service

Warranty and service description

If the product is damaged in detail, please contact BUYDEEM customer service centre or send the service point for repair.

- The warranty is limited to production defects and damage caused by correct use in accordance with the instructions. Damage caused by improper use or other non-product quality issues will be charged for repairs.
- Customers whose products are beyond warranty period can contact the after-sales serves center of purchase channel if want to buy product spare part.

The following conditions will not be repaired free of charge

- No Guarantees Certificate or valid invoice.
 - Failure caused by failure to operate in accordance with the instructions
- A. Damage caused by improper use, storage and maintenance by consumers.
B. Damage caused by repairs not performed by the company's designated maintenance department.
C. Damage due to force majeure.

For the benefit of customers, BUYDEEM reserves the right to modify product features and components to ensure the normal use of the product.

If you need more services and information, or any questions, please contact the after-sales serves center.

Warranty & Service

Warranty card

BUYDEEM

Dear Customer,

Thank you so much for your purchase! The product comes with a ONE-YEAR warranty.

Should you ever needs one, please have the following information handy when contacting us:

Product Model No.: _____ Product Name: _____

Factory Serial No.: _____ Order Date: _____

Order ID: _____ Customer Name: _____

Customer Phone: _____ Customer email: _____

Please feel free to email us if have any questions or concerns.

感谢您购买北鼎产品，为了能让您充分享受北鼎全方位的支持，
使用本产品之前请仔细阅读本说明书及相关图解。

目录

Contents

注意事项	28	使用产品	38~44
技术规格	29	初次使用	38
认识产品	30~37	使用指引	39
产品结构图	30	沸点检测	45
功能模式介绍	31	特色功能	48
部件介绍	33	清洁和保养	49
		简单故障处理	50
		环保清单	51
		保修和服务	52

⚠ 危险

- 切勿在无人看管的情况下运行本产品，以防产品突发情况造成火灾等危险。
- 为防止触电或短路等危险，切勿将养生壶、底座、电源线及插头置于水中或其它任何液体中。

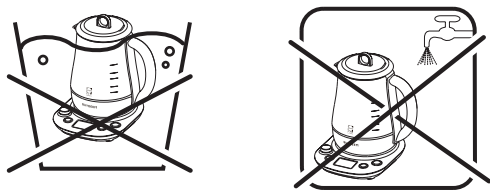

⚠ 警告

- 儿童、老年人、肢体或精神能力受限人士及无使用经验人士应在监督和指导下使用产品，并保证其安全。儿童应在监管下接触本产品，以确保他们不会将产品当成玩具玩耍。
- 本产品必须单独使用额定电流10A以上，额定电压120V~60Hz的接地插座，插头需完全插入插座，以防接触不良而导致元件过热烧坏，引发短路或火灾等危险。切勿使用万能插座。
- 请将养生壶和电源线远离高温、明火、潮湿、光滑的台面或锋利的边缘，以防引起器件损坏、故障或火灾。
- 手沾水或赤脚时禁止使用养生壶。

⚠ 注意

- 本产品仅设计为家庭使用，厂商仅对生产瑕疵和家用故障进行保修；任何商业用途、不适用用途或未遵照说明操作而造成的后果与故障，厂商均不负任何责任，此等故障损坏均不属于保修范围内。
- 使用前请核对产品规格标贴上显示的电压与主电压是否一致。
- 本产品必须和其配套的底座一起使用，请勿使用其它底座。
- 请始终将养生壶放置在平坦、稳固、耐热的工作台上。
- 使用产品前，请务必确认上盖已正确盖好，以防烫伤。
- 养生壶在工作期间会产生高温和蒸汽，请勿在工作期间揭开壶盖、触碰或移动养生壶、靠近蒸汽出口等高温部分，以防烫伤。
- 请勿将密闭的容器放置在壶内加热，以防引起爆炸的危险。
- 请勿在超过最大水位或低于最低水位的情况下运行养生壶；养生壶内装水或食材过满，可能会引起沸水溅出，养生壶内装水或食材过少，可能会引起干烧或糊底。
- 养生壶要防潮、防冻，请勿将养生壶放进冰箱。

⚠ 注意

- 为防止触电或火灾，请保证下列情况下电源是断开的：空壶时、不使用养生壶时、清洁或移动养生壶时、养生壶部件损坏时、当养生壶出现故障时。
- 如果长时间不使用养生壶，建议将养生壶内的水倒掉。
- 如需拔下插头，请手握住插头再拔出，请勿强行拉扯或扭曲电源线，以防电源线损坏，产生漏电危险。
- 请不要让电源线悬挂在桌子或工作台面边缘之外，以防养生壶掉落，或引起绊倒。
- 请不要用非推荐的方法除水垢，推荐方法详见P49。
- 为避免显示屏刮花，请使用柔软布料擦拭表面。
- 建议使用纯净水烹饪。因水垢过多导致发热盘故障，请定期清洗发热体上的水垢。
- 如发现养生壶部件损坏或不能正常工作时，请立即拔掉电源插头，切勿继续使用，也勿自行拆除，请前往北鼎授权的服务中心进行更换或维修。
- 除了按照说明书进行清洁和除垢，其它任何非正常使用操作必须由北鼎授权的服务中心进行。
- 由于未对养生壶进行除垢造成其不能正常使用或完全不能使用的情况，不属于保修范围。
- 因为所有产品均严格按照质量控制程序，其中包括对随机抽检产品的实际使用测试，所以其将对产品的任何使用痕迹作出解释。
- 如果电源线损坏，为避免危险，必须由北鼎的售后维修部门人员来更换。

技术规格

产品名称	多功能电水壶(养生壶)		产品型号	K2763	
产品功率	1000W	最大容量	1.5L	电压	120V~ 60Hz

本产品采用食品接触用材质：
SUS304 (06Cr19Ni10) 及SUS316L (022Cr17Ni12Mo2) 不锈钢、
德国肖特高硼硅玻璃(可用于烹饪使用)、聚丙烯PP塑料、食品接触用硅胶

产品结构图

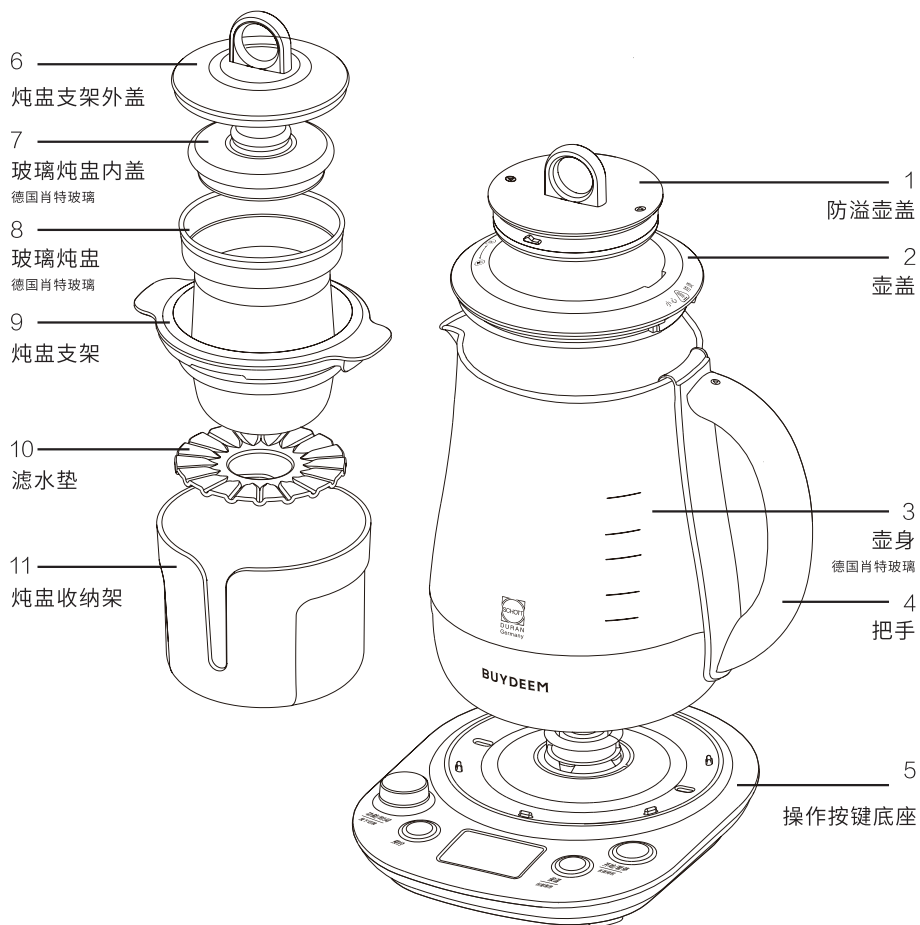

按键功能介绍

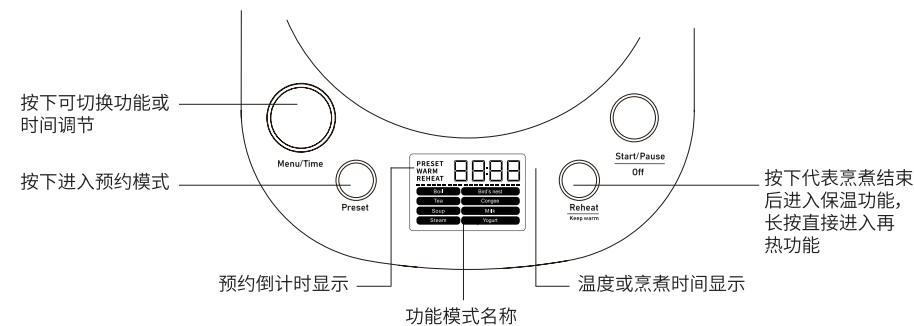

功能类型	功能名称	时间/温度范围(旋钮)	功能运作方式	保温(手动开启)
基础功能	烧水	六个温度段可调: 40/50/60/70/85和100°C	快速烧水至目标温度后停止工作。 注意: 请勿用此功能键加热除水以外的汤汁/液体, 否则可能出现溢出现象。	煮沸后保温 70°C, 2小时; 其他温度段保温 对应温度, 2小时
	保温/长按再热 (70°C/2小时)	/	1. 短按代表煮煮结束后进入保温功能。 2. 长按直接进入再热功能。当水温低于70°C时, 加热水至70°C后自动保温2小时; 若水温高于70°C时, 直接进入保温状态。 ps: 预约或煮煮模式下无法进入再热功能。	70°C, 2小时
煮功能	养生汤 (默认1小时)	30分钟-2.5小时	水烧开后按照养生汤模式工作1小时, 可手动开启自动保温。	70°C, 2小时
	花果茶 (默认10分钟)	5-20分钟	水烧开后按照花果茶模式工作10分钟, 可手动开启自动保温。	70°C, 2小时

功能类型	功能名称	时间范围(旋钮)	功能运作方式	保温(手动开启)
炖功能 (配合炖盅使用)	燕窝 (默认30分钟)	20-45分钟	水烧开后按照燕窝模式工作30分钟,可手动开启自动保温。	70°C, 2小时
	粥汤 (默认1小时)	30分钟-2小时	水烧开后按照粥汤模式工作1小时,可手动开启自动保温。	70°C, 2小时
	酸奶 (默认8小时/40°C)	8-9.5小时	先加热壶中水至40°C后按照酸奶模式恒温8小时。若养生壶内水温过高,选择“酸奶”功能时,显示屏显示E1,养生壶会发出警报声后自动停止工作。	/
	温奶 (默认10分钟/60°C)	5-20分钟	先加热壶中水至60°C后按照温奶模式工作10分钟,无自动保温功能。	/
蒸功能 (配合蒸笼使用)	蒸 (默认15分钟)	5分钟-1小时	水烧开后按照蒸模式工作15分钟,可手动开启自动保温。	70°C, 2小时
预约模式	预约	30分钟-18小时	按下此按键可进入预约模式,根据设定的预约时间倒计时后,将自动进入选定的烹煮功能。 提示:若处在预约模式,显示的预约时间不包含汤水烹煮时间。	/
其他	开始/暂停	/	按下此按键,养生壶开始/暂停工作。 长按2秒进入待机状态。	/

注意!

1. 必须配套使用K2763壶身及K2763线座,切勿将其他品牌养生壶或北鼎其他型号养生壶与K2763混用,否则可能出现无法正常使用的情况,甚至出现短路、触电等危险。
2. 以上烹煮时间均从水烧开后开始计时,不含水烧开时间。

部件设计

防溢壶盖设计

- 养生壶按照用户日常使用习惯,加入两个盖子相互嵌套的“防溢壶盖”独特设计。
- 在养生壶正常工作时,用户可以随时拧开防溢壶盖来观测食物烹煮状态,从而选择加料或调味等各种操作。
- 若食物烹煮时产生过多的泡沫,建议打开防溢壶盖,可有效防止溢出。

1. 防溢壶盖安装:

- 握住提手抵住壶盖,顺时针旋转拧紧即可。

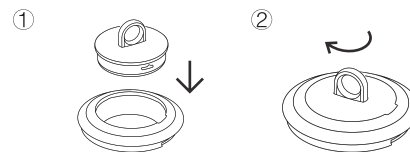

2. 防溢壶盖拆卸:

- 握住提手抵住壶盖,逆时针旋转拧开即可。

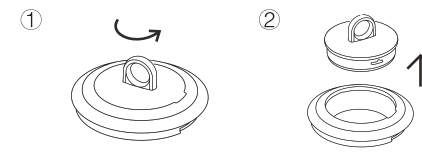

玻璃炖盅介绍

△注意:

- 请勿在养生壶安装炖盅后进行倒水操作, 以防炖盅与支架掉落造成烫伤危险。
- 请勿将玻璃炖盅直接明火加热。
- 请勿将玻璃炖盅放入烤箱或微波炉内加热。
- 炖盅的有效最大容量为500ml(约炖盅高度7成), 使用时请勿超出最大容量, 以免使用过程中食材溢壶造成烫伤。

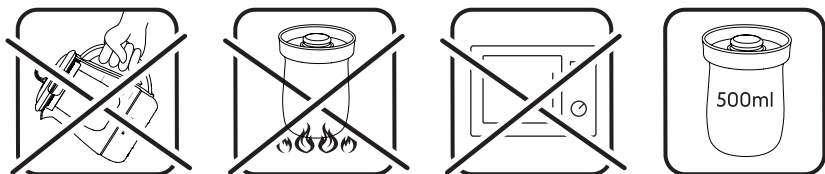

1. 玻璃炖盅安装:

- 将炖盅置于支架内;
- 将支架连炖盅一起提起;
- 安装在养生壶上并盖上大盖子, 注意需对齐支架三角标识与壶身把手三角标识。

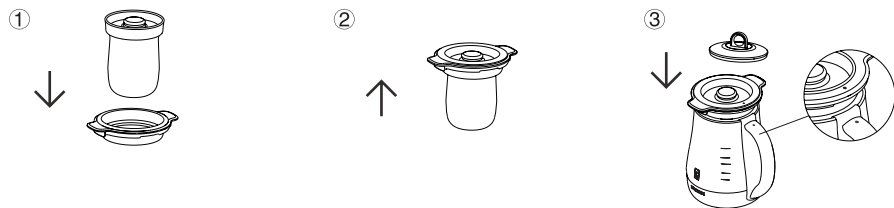

2. 玻璃炖盅拆卸:

- 提起支架连炖盅一起取出;
- 轻轻放下支架;
- 拿走支架盖子, 取出炖盅。

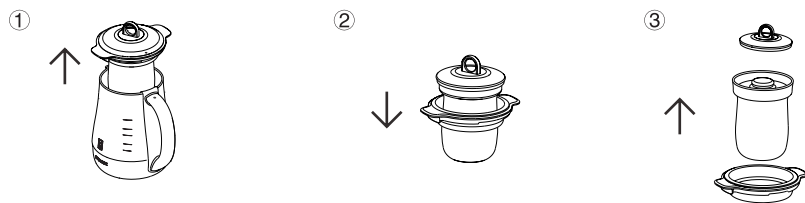

炖盅收纳设计

- 为方便用户收纳和晾晒炖盅, 养生壶加入炖盅收纳架的独特设计。
- 用户可在使用完炖盅后将炖盅置于收纳架中晾干; 晾干后可将炖盅放置于收纳架中收纳。

1. 晾晒炖盅:

- 洗净炖盅后, 先将玻璃内盖放入收纳架;
- 倒扣玻璃炖盅;
- 依次放下炖盅支架和炖盅支架外盖;
- 将炖盅及炖盅支架如图示放置直至晾干。

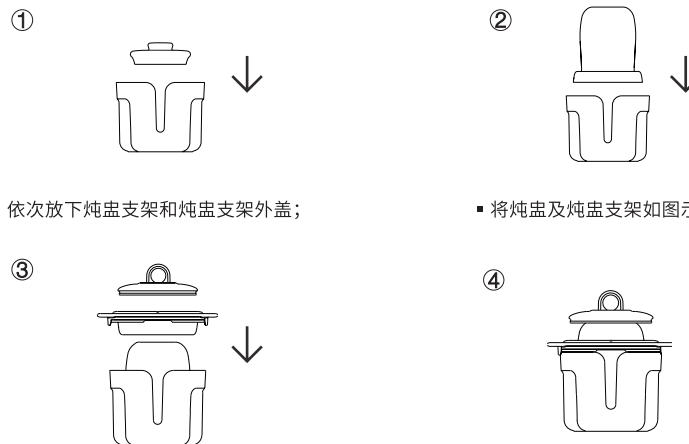

2. 收纳炖盅:

- 将炖盅放入支架内;
- 将支架与炖盅提起一起放入收纳架内, 再放入支架外盖。

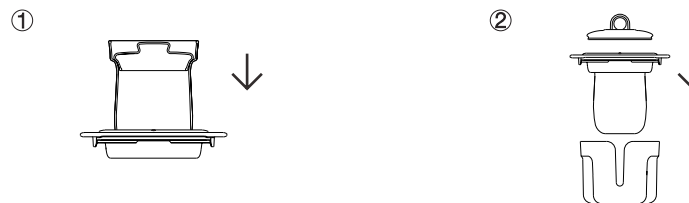

蒸笼设计

- 蒸笼不属于产品标配, 需单独购买。
- 本产品须搭配北鼎养生壶使用。使用时选择蒸功能, 并且壶内的水量控制在750ml至1500ml之间, 以免干烧或溢壶等意外发生。
- 由于食物自身属性或粘附污垢, 使用蒸功能时更容易将污垢沉淀在养生壶底部, 造成水垢或污点。建议使用纯净水烹饪, 并定期清洗发热盘, 可参考P23进行清洗, 防止水垢过多导致发热盘故障。
- 打开上盖时, 请注意蒸汽, 以防烫伤。
- 请勿使用蒸功能的同时在壶内中煮食材。
- 请勿用布等遮盖蒸汽口, 以免引起事故或造成产品损坏。
- 请勿用明火直接加热, 或放入微波炉和烤箱中加热。
- 使用过程中, 务必在防烫提手范围内移动笼身及笼盖, 并注意蒸汽, 以避免烫伤、滑落等危险发生。
- 使用时请确保笼内底孔未被堵塞, 以免蒸汽无法进入蒸笼而影响烹煮效果。

1. 蒸笼安装:

- 将蒸笼置于养生壶上方;
- 对准过滤口及把手卡位后放入即可。

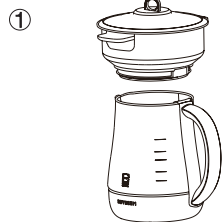

2. 蒸笼拆卸:

- 双手握住蒸笼把手后取出蒸笼, 注意水蒸汽以免烫伤;
- 将蒸笼放置平坦的台面上。

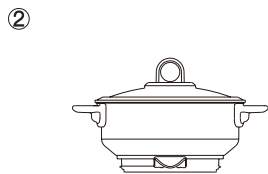
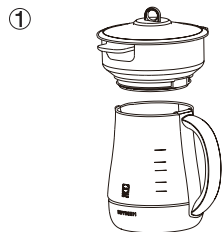

过滤茶篮设计

- 过滤茶篮不属于产品标配, 需单独购买。
- 为了方便用户过滤不食用的食材/茶叶, 养生壶加入提手式茶篮的独特设计。
- 在烹煮过程中, 用户可将不食用的食材放入茶篮中; 若担心味道过浓, 可在烹煮过程中打开茶篮盖, 将茶篮取出。

1. 过滤茶篮安装:

- 抓住茶篮提手, 把茶篮放入壶盖中空部分;
- 顺时针拧紧茶篮盖, 当听到一声轻微“啉啉”声时, 表示已经拧紧;
- 将整个盖子放入养生壶安装在壶口, 滤网对准壶嘴, 轻轻按压使壶盖合紧。

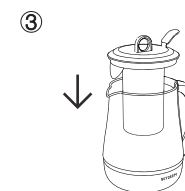
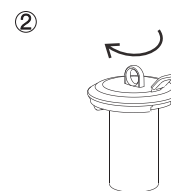
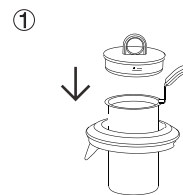

2. 过滤茶篮拆卸:

- 把茶篮盖逆时针拧开;
- 抓住茶篮提手, 提出茶篮。

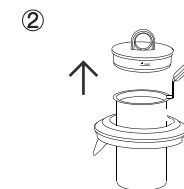
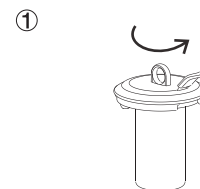

茶座杯设计

- 为了方便用户放置及收纳茶篮, 养生壶加入茶座杯的独特设计。
- 茶篮从养生壶中取出时, 可放置在茶座杯中, 防止茶篮滴水沾湿桌面。

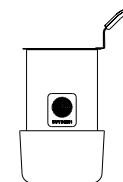

一、初次使用

1. 去除养生壶内外所有包装, 标签及附件。
在初次使用产品之前, 我们建议您做一次沸点检测操作 (详见P45)。

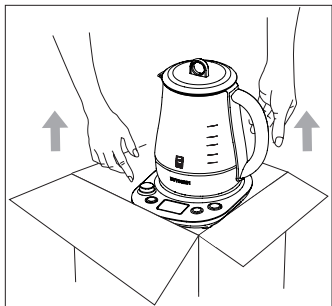

2. 前2-3次煮水应该倒掉用于清洁, 然后用湿布擦拭养生壶部件的外部 (请注意壶底和底座上的电子连接器不可接触水)。

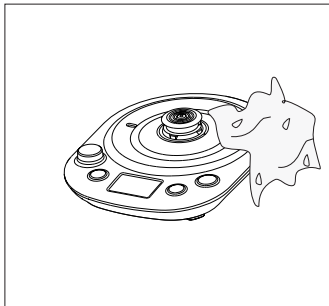

二、快速安装

1. 通过底座的绕线装置调整电源线的长度。

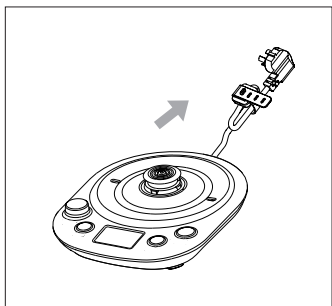

2. 将养生壶放到底座上。

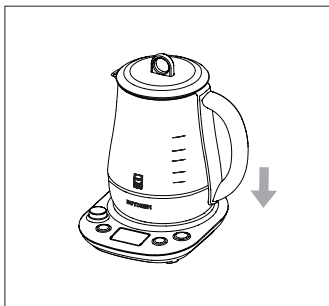

使用指引

煮功能



1. 打开壶盖

- 拉紧防溢壶盖提手, 向上拉即可取出壶盖。



2. 加入食材

3. 加入适量纯净水

- 当养生壶在底座上时请勿加水。
- 切勿加水 and 食材超过最大水位或低于最小水位。
- 若加水过满, 沸腾时可能会溅出水。
- 请注意, 对于银耳、黄芪、黑茶等容易起泡的食材, 建议加水到1200ml水位线即可, 并在烹煮时打开防溢壶盖。



4. 盖紧壶盖

- 将壶盖按图示位置放置在壶身上, 请确认壶嘴滤网是否对准壶嘴, 轻轻按压使壶盖合紧, 用手轻轻提起, 若提不起, 表示盖子合紧。
- 如盖子装配不到位, 倒水时, 盖子容易掉下来。





5. 将养生壶放在底座上

- 请将壶底及底座面上的水擦干。
- 底座务必放置在平坦、干净的耐热台面上。
- 养生壶壶身必须使用专属的底座。
- 养生壶内无水时请勿使用。

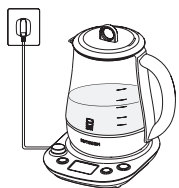

6. 插上电源

- 当养生壶通电，蜂鸣器发出响声，按键灯闪烁后灯灭，表示进入待机状态，可开始选择功能工作。

炖功能



1. 在玻璃炖盅里加入食材

- 将食物放入炖盅内，加入适量的水，按P8所示安装好炖盅。



2. 加入适量纯净水

- 加水至养生壶刻度1000ml(放盅前水位)。
- 当养生壶在底座上时请勿加水。

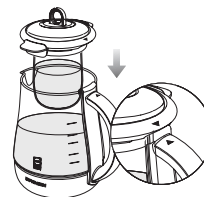

3. 安装壶盖

- 将支架连炖盅提起，安装在养生壶上。
- 请注意！请确认支架上三角标识对齐壶身把手上的三角标识，否则说明炖盅支架没安装好。



4. 将养生壶放在底座上

- 请将壶底及底座面上的水擦干。
- 底座务必放置在平坦、干净的耐热台面上。
- 养生壶壶身必须使用专属的底座。
- 养生壶内无水时请勿使用。

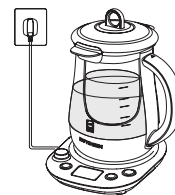

5. 插上电源

- 当养生壶通电，蜂鸣器发出响声，按键灯闪烁后灯灭，表示进入待机状态，可开始选择功能工作。

功能模式使用指引

step 1: 功能选择。

使用旋钮左右旋转, 选择任意烹煮功能模式, 选定功能跳闪, 屏幕右上方出现当前功能默认时长。如花果茶, 默认烹煮10分钟。

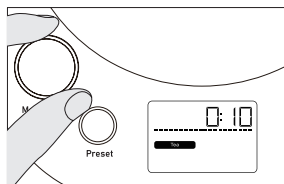

step 2: 温度/时间调节。

烧水功能时, 按下旋钮后进入烧水温度调节界面。

其他功能模式下, 按下旋钮进入烹煮时长调节界面。如选定花果茶, 旋转旋钮调节烹煮时长为15分钟。

若无需调节烧水温度或烹煮时间, 可直接跳至step3。

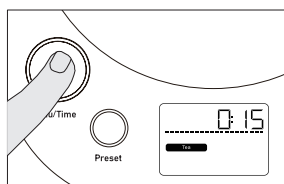

step 3: 功能确认并开始。

按下“开始/暂停”键进入烹煮阶段。

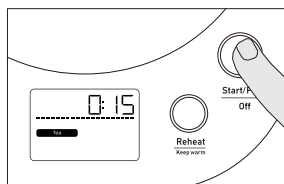

step 4: 烹煮过程。

当烹煮开始后, 显示屏呈阶段性显示, 以花果茶为例, 分别为:

1. 机器先大火将壶水加热至指定温度, 显示屏显示当前壶水温度

2. 进入小火变频慢煮时, 显示烹煮时长倒计时

3. 烹煮结束后, 若开启保温功能, 显示保温倒计时

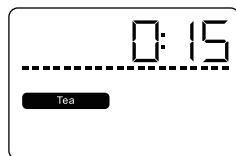
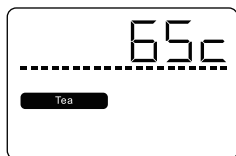

提示: 如果是烧水功能, 显示屏始终显示当前壶水温度, 不显示倒计时。

保温功能使用指引

选任一功能时, 按下“保温”按键, 灯圈亮起, 功能完成后机器将自动进入70°C, 2小时保温。

提示: 因食材特殊性, “酸奶”和“温奶”功能无法开启自动保温。

长按再热功能使用指引

step 1: 长按“保温”按键2秒, 屏幕出现“加热”和“70°C”。

注意: 预约和烹煮模式下无法进入再热功能。

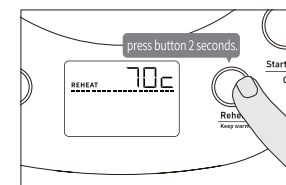

step 2: 按“开始/暂停”按键, 机器启动再热功能。即将汤水加热至70°C后保温2小时。

提示: 启动再热功能前需搅拌汤水, 以防因食材沉底而糊底。

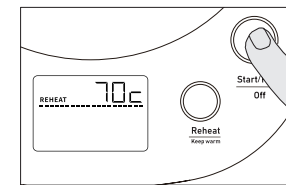

预约功能使用指引

step 1: 预约准备。

按下“预约”按键进入预约时间选择界面, 可通过旋钮调节预约时间。
如选择养生汤模式1小时, 预约8小时。

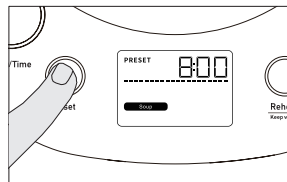

step 2: 预约修改。

在预约准备阶段, 可随时按下旋钮进行三大界面切换: 预约时间---功能选择---烹煮时长。当前界面跳闪, 并通过旋钮旋转调整任一功能或时间。

step 3: 预约确认。

选择好预约时间、功能及烹煮时长后, 按下“开始/暂停”按键养生壶进入预约倒计时。进度灯跑动。

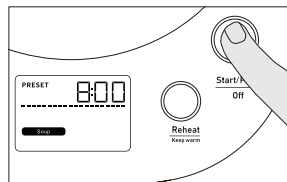

step 4: 预约取消或暂停。

若在预约准备阶段, 可随时按下“预约”按键退出预约模式; 若已进入预约倒计时, 则可先按下“开始/暂停”键后, 按键暂停程序后, 再按下“预约”按键取消预约, 退出预约界面。

提示: 因食材特殊性, “酸奶”、和“温奶”功能无预约模式。

沸点检测记忆程序

- 由于在非零海拔地区, 水在沸腾时无法达到100°C, 这将导致普通养生壶无法正常工作 (跳断过慢甚至无法正常跳断)。
- 北鼎建议您在第一次使用时, 均进行一次沸点检测操作。检测完成后, 芯片将记录精确沸点数据, 再次使用无需重复检测。
- 经过沸点检测后, 养生壶能更精准地工作 (性能比出厂设置时更佳)。
- 若您处于海拔高于250m的城市, 请务必进行沸点检测操作后再使用。

启动沸点检测

1. 加水至1200ml水位线, 水量不足或过多时, 会影响检测结果。
2. 放入线座, 先不通电。



沸点检测 / Boiling point

3.同时按住“保温”和“开始/暂停”按键,按稳后再将电源插头插入电源,听到短鸣一声后,屏幕显示“H1”,此时方可松开手指。

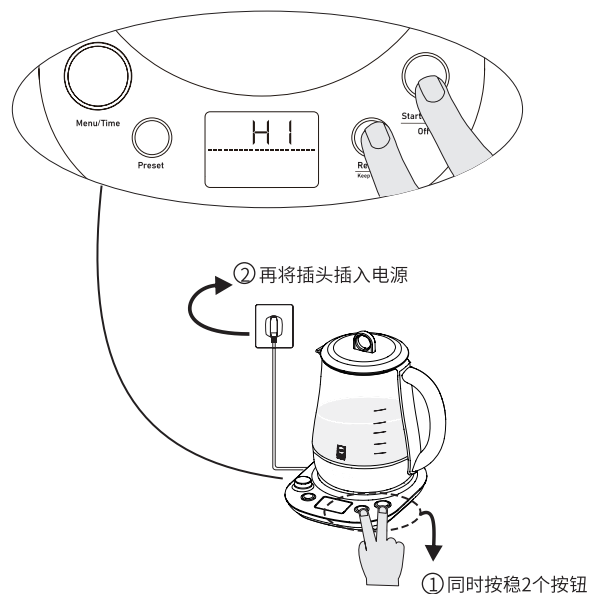

4.“开始/暂停”灯圈闪烁,按一下“开始/暂停”键开始检测。

开始检测后,屏幕继续显示“H1”,同时进度条跑动。检测完成后会响关机声,自动结束工作并进入待机状态。

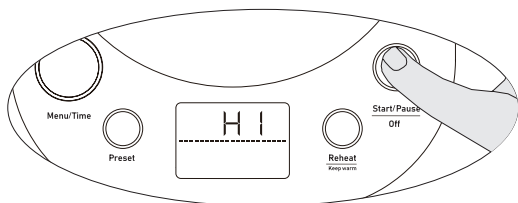

沸点检测 / Boiling point

沸点恢复出厂设置

机器具有沸点恢复出厂设置功能。

同时按住旋钮和“预约”按键,插入电源插头,保持按按键2秒,机器进入沸点恢复出厂设置模式,此时4个按键灯循环显示一次,之后响关机声,自动进入休眠模式,沸点恢复成出厂设置100°C。

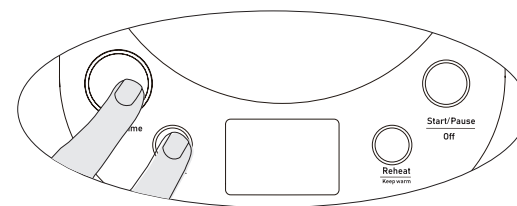

壶暂停记忆功能

养生壶按照程序进行工作时,可通过提壶或按“开始/暂停”来使其暂停工作,暂停1个小时内再通过放壶或按“开始/暂停”来开始工作,养生壶将执行暂停前未完成的程序时间,不会重新执行一遍功能程序。

避免误操作

养生壶开始工作的1分钟内,可按下旋钮任意切换模式。切换模式或时间后,需再次按下“开始/暂停”按键进入烹煮状态。

为了避免误操作,养生壶开始工作1分钟后,不能随意切换功能。若需要切换功能,需先按“开始/暂停”按键,“开始/暂停”按键闪烁,再选择需要切换的程序。

冷水保护

养生壶工作时,如在烹煮中途加入冷水,养生壶会自动重新将水烧开后再执行未完成的程序,无需担心生冷隐患。

清洁和保养

养生壶的清洗

1. 拔下电源插头。
2. 待水壶冷却后,用湿海绵清洗养生壶内部。
注意:切勿将养生壶、底座、电源线或插头浸泡水中(壶底及底座上的电子连接器不可接触水)。
3. 每次使用后,为避免食物变质,请及时清洗。

显示屏保养

为避免显示屏刮花和损坏,请用干燥的软布轻轻擦拭表面。

除水垢

养生壶需定期除水垢,至少每月一次,如水质较差则应增加次数。

发热盘如出现斑点,此为水垢,属于正常现象,用百洁布轻轻擦洗即可清洗干净。若情况较为严重,可采用以下方式进行除垢。

养生壶除垢小贴士

使用白醋:

- 往养生壶内加入100ml白醋。
- 往养生壶内加水至500ml刻度线。
- 启动“烧水”模式。
- 程序结束后,静置1小时,然后用百洁布将壶底擦净即可。

使用柠檬酸:

- 往养生壶内加入500ml清水。
- 加入10g柠檬酸。
- 启动“烧水”模式。
- 待自动断电后,静置5-10分钟。(若水垢较多,可延长静置时间)
- 最后将壶内水倒掉,用百洁布将壶底擦净即可。

简单故障处理 / Simple Troubleshooting

简单故障处理

故障现象	原因分析	故障排除
安装后,无提示声音且按键灯不亮	未接通电源	检查插座是否已插好
	煲身与底座没有连接到位	煲身放上线座后,可旋转或调整位置,确认已连接到位
	线座故障	建议送服务点维修
提示音持续响	干烧保护(一般按键灯全亮)	冷却数分钟后,再倒入冷水继续使用
	NTC异常	建议送服务点维修
壶加热10秒后停止工作,短鸣3声后自动关机	壶内水温高温提示	一般此情况会出现在保温、酸奶、温奶等功能,壶内水温高于程序设定的温度,加入冷水再继续工作。
水有异味	未使用过的新养生壶	新养生壶使用前建议煮几次水倒掉,如果状况持续发生,将水注满至最高水位,并加两茶匙的苏打,煮沸后倒掉,再清洗养生壶。

显示屏故障代码对应表

显示屏代码	故障原因	解决措施
E1	超温警告	使用低于目标温度的纯净水
E2	干烧	冷却数分钟后,再倒入冷水继续使用
E3	壶身与底座型号不一致	使用同一型号的养生壶壶身和底座

环保清单 / List of Environmental Protection

环保清单

产品中有毒有害物质或元素的名称与含量

部件名称	有害物质					
	铅(Pb)	汞(Hg)	镉(Cd)	六价铬(Cr(VI))	多溴联苯(PBB)	多溴二苯醚(PBDE)
壶盖组件	○	○	○	○	○	○
壶身组件	○	○	○	○	○	○
底座组件	○	○	○	○	○	○
发热盘组件	×	○	×	○	○	○
电路板组件	×	○	○	○	×	×
电源线	×	○	○	○	○	×

○:表示该有害物质在该部件所有均质材料中的含量均在GB/T 26572规定的限量要求之下。

×:表示该有毒有害物质至少在该部件的某一均质材料中的含量超出GB/T 26572规定的限量要求。



环保使用期间10年:表示本产品中含有的有害物质不会发生外泄或突变,用户在产品说明书所述情况下正常使用本产品不会对环境造成严重污染或对其人身、财产造成严重损害的期限。

箭头循环标志:表示本产品可回收利用。超过使用期限或经过维修无法正常工作后,不应被随意丢弃,请交由正规回收渠道以及有废弃电气电子产品处理资格的企业处理,正确的处理方法请查阅国家或当地有关旧电器电子产品的处理规定。

以上标识均依据中国有害物质限制使用管理办法及其配套标准SJ/T 11364要求执行。

产品长期使用不会对人体产生危害,请放心使用

保修和服务说明

如果产品有明细损坏, 请您扫描下方二维码进入售后中心, 选择“自助报修”并填写相关信息提交。北鼎售后专席客服将于24小时内(节假日除外)给您处理。

- 保修仅限生产缺陷及参照说明书正确使用造成的损坏。因使用不当或其他非产品本身质量问题造成的损坏, 将收取维修费用。
- 如需购买产品零配件, 可联系平台客服购买

以下情况恕不免费维修

- 无三包凭证及有效发票
 - 未按说明书的要求操作引发的故障
- A. 消费者使用、保管、维护不当造成的损坏。
- B. 非本公司指定维修部自行装拆修理而造成的损坏。
- C. 因不可抗力造成的损坏。

为了客户的利益, 北鼎保留对产品特性及组件做出修改的权利, 以确保产品的正常使用。

关于保修

北鼎根据“新三包”政策为您提供售后服务, 整机保修一年。

填写延保卡注意事项

- 1、线上店铺购买的产品请填写您的订单号并上传订单截图。
- 2、线下实体店购买的产品请填写您的购机时间并上传购机发票或者小票。
- 3、如您报修时提供的产品信息与延保信息不符, 则无法按延保的售后政策为您提供售后服务。

