

BUYDEEM

K1563

Electric Steam Brewer

Instruction Manual



BUYDEEM

Shenzhen Crastal Technology Co., Ltd.

Block 7&8, D Industrial Zone, Buchong, Shajing, Bao' an,
Shenzhen City, Guangdong province, P. R. China

Please read the user manual carefully before using this product. Please keep the user manual properly.

Actual products may vary due to minor product enhancement.

K1563-91-A2

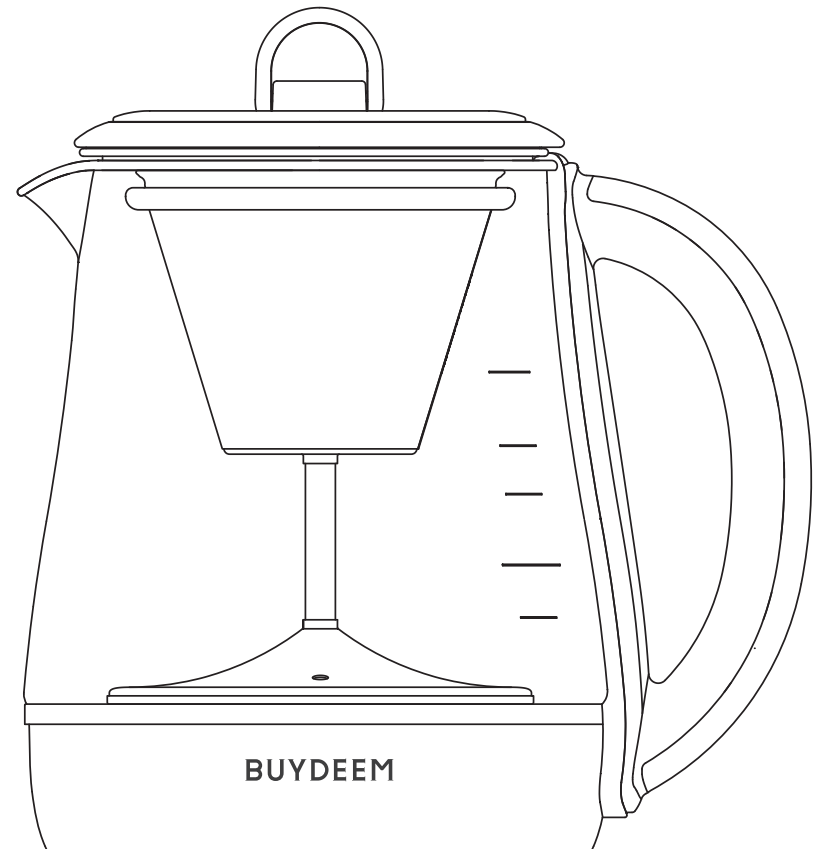

Thank you for purchasing products from BUYDEEM. To ensure that you can fully enjoy BUYDEEM's all-around support, please read this manual carefully and completely before operating this product.

TABLE OF CONTENTS

Important Safeguards	/ 01-07
Technical Specifications	/ 04
Product Overview	/ 08-12
Operating Instructions	/ 13-16
Boiling Point Measurement	/ 17-18
Special Functions	/ 19
Cleaning and Maintenance	/ 20
Basic Troubleshooting	/ 21
Warranty and Service	/22

BUYDEEM

IMPORTANT SAFEGUARDS

When using the electrical appliance, please always take the following basic safety precautions:

Read All The Instructions.

- **DANGER**
 - Do not leave the product operating unattended to prevent any emergencies that could cause fire hazards or other dangers.
 - Do not touch the hot surfaces. Please use the handle.
 - To prevent the risks of electric shocks or short circuits, please do not put the electric steam brewer, power cord, or plug in water or any other liquid.



- **WARNING**
 - Children, the elderly, people with limited physical or mental abilities, and those without any experience of using similar products should only use this product under supervision and guidance, which ensures their safety. Children must not have access to this product when unattended so that they would not mistake it as a toy to play with. Close supervision is necessary when any appliance is used by or near children.
 - This product must be used alone with a grounded outlet with a rated current above 10 A and a rated voltage of 120 V, 60 Hz. The plug must be fully inserted into the outlet to prevent overheating of the components caused by poor contact, which might lead to the risks of short circuits or fire hazards. Do not use a universal outlet.
 - Please keep the electric steam brewer and power cords away from high temperatures, open flames, damp, smooth surfaces, or sharp edges to prevent component damage, failures, or fire hazards. Do not let cord hang over edge of table or counter, or touch hot surfaces.
 - Please do not use the electric steam brewer with wet hands or bare feet.
 - This product is not intended for outdoor use.
 - Do not place on or near a hot gas or electric burner, or in a heated oven.

IMPORTANT SAFEGUARDS

- **WARNING**
 - Please do not use the electrical appliance for purposes other than its intended use.
 - Unplug from outlet when not in use and before cleaning. Allow to cool before putting on or taking off parts, and before cleaning the appliance.
 - The use of accessory attachments not recommended by the appliance manufacturer may result in fire, electric shock or injury to persons.
 - To disconnect, turn any control to 'off', then remove plug from wall outlet.
- **CAUTION**
 - This product is designed for household use only. The manufacturer only provides warranty repair for production defects and faults arising from household use. The manufacturer is not responsible for any consequences or faults caused by any commercial use, unsuitable use, or failure to follow the instructions. Such faults and damage are not covered by the warranty. **WARNING:** Risks of injuries if you don't use this appliance correctly.
 - Please check whether the voltage displayed on the product specification label is consistent with the main voltage before using the product.
 - This product must be used together with its matching base. Please do not use other bases.
 - Please always place the electric steam brewer on a flat, stable, and heat-resistant workbench.
 - Before using the product, please make sure the top lid is properly closed. Otherwise, it might lead to the risk of scalding.
 - During operation, the electric steam brewer will generate high temperatures and vapor. Do not open the brewer lid, touch or move the electric steam brewer, or get close to the steam outlet and other parts of high temperature. Otherwise, it might lead to the risk of scalding. The heating element surface is subjected to residual heat after use.
 - Please do not heat an airtight container in the brewer. Otherwise, it might lead to the risk of an explosion.
 - Please do not use the electric steam brewer when the water level is above the maximum or below the minimum level. Overfilling the electric steam brewer with water or ingredients might cause boiling water to splash out while filling it with too little water or ingredients might lead to a scorched bottom or cause the brewer to boil dry. **WARNING:** Avoid spillage on the connector.
 - Keep the electric steam brewer from moisture and freeze. Please do not put the electric steam brewer in the fridge.

IMPORTANT SAFEGUARDS

- **CAUTION**
- K1563 uses touch buttons. If the product is in standby mode after the power is connected, it is normal for the touch buttons to be triggered when they are wiped with a damp cloth, which would not affect normal use.
 - To prevent electric shock or fire, please ensure that the power is disconnected under the following circumstances: 1) when the brewer is empty; 2) when the electric steam brewer is not in use; 3) when cleaning or moving the electric steam brewer; 4) when parts of the electric steam brewer are damaged; or 5) when the electric steam brewer malfunctions.
 - It is recommended to empty the electric steam brewer if it is not used for a long time.
 - If you need to pull out the plug, please hold the plug with your hands and pull it out. Please do not pull or twist the power cord by force. Otherwise, a risk of electric leakage might occur due to damage to the power cord.
 - Please do not hang the power cord outside the edge of the table or workbench surface. Otherwise, the electric steam brewer might fall or cause trip hazards.
 - Please do not descale the electric steam brewer with other methods that are not recommended. For recommended methods, please refer to the cleaning instructions in the following sections.
 - It is suggested to use purified water. To avoid malfunctions in the heating plate caused by excessive scale buildup, please clean the scale on the heating element regularly.
 - If the components of the electric steam brewer are damaged or cannot work properly, please unplug the power plug immediately. Do not use it or dismantle it by yourself. Please come to a service center authorized by BUYDEEM for replacement or repair.
 - Any other use and operations apart from normal cleaning and descaling that are specified in the manual must be conducted by a service center authorized by BUYDEEM.
 - Any malfunction or failure to work caused by a lack of cleaning and descaling to the electric steam brewer is not covered by the warranty.
 - All products are manufactured following the quality control procedure, including the actual use testing of randomly selected products, which explains any evidence of use on the products.
 - If the power cord is damaged, it must be replaced by a professional from the manufacturer, its service department, or a similar department to avoid danger.

TECHNICAL SPECIFICATIONS

- **CAUTION**
- Sort Cord Instruction:
 - a) A short power-supply cord is provided to reduce risks resulting from becoming entangled in or tripping over a longer cord.
 - b) Extension cords are available and may be used if care is exercised in their use.
 - c) If extension cord is used:
 - 1) The marked electrical rating of the extension cord should be at least as great as the electrical rating of the appliance;
 - 2) If the appliance is of the grounded type, the extension cord should be a grounding- type 3-wire cord;
 - 3) The longer cord should be arranged so that it will not drape over the counter top or table top where it can be pulled on by children or tripped over.

SAVE THESE INSTRUCTIONS.

— TECHNICAL SPECIFICATIONS

Name	Electric Steam Brewer		Model	K1563	
Rated Power	1000W	Rated Capacity	1.5L	Rated Voltage	120V~ 60Hz

This product is made of food contact materials:
food contact SCHOTT DURAN high borosilicate glass made in Germany, SUS304 (06Cr19Ni10), SUS316L (022Cr17Ni12Mo2) stainless steel, polypropylene, and food contact silicone.

IMPORTANT INSTRUCTION

Lors de l' utilisation de l' appareil électrique, veuillez toujours prendre les précautions de base suivantes :

Lisez toutes les instructions.

- **DANGER**
 - Ne laissez pas l' appareil fonctionner sans surveillance afin d' éviter tout risque d' incendie ou autre.
 - Ne touchez pas les surfaces chaudes. Veuillez utiliser la poignée.
 - Pour éviter les risques de décharges électriques ou de courts-circuits, ne mettez pas la bouilloire électrique, le cordon d' alimentation ou la fiche dans l' eau ou dans tout autre liquide.



— AVERTISSEMENT

- Les enfants, les personnes âgées, les personnes ayant des capacités physiques ou mentales limitées et celles qui n' ont pas l' habitude d' utiliser des produits similaires ne doivent utiliser ce produit que sous surveillance et avec des conseils, ce qui garantit leur sécurité. Les enfants ne doivent pas avoir accès à ce produit lorsqu' ils sont sans surveillance, afin qu' ils ne le prennent pas pour un jouet.
- Ce produit doit être utilisé seul avec une prise de terre dont le courant nominal est supérieur à 10 A et dont la tension nominale est de 120 V, 60 Hz. La fiche doit être complètement insérée dans la prise afin d' éviter une surchauffe des composants due à un mauvais contact, ce qui pourrait entraîner des risques de court-circuit ou d' incendie. N' utilisez pas de prise universelle.
- Conservez la bouilloire électrique et les cordons d' alimentation à l' écart des températures élevées, des flammes nues, des surfaces humides et lisses, ou des bords tranchants, afin d' éviter tout risque d' endommagement des composants, de défaillance ou d' incendie.
- N' utilisez pas la bouilloire électrique avec les mains mouillées ou les pieds nus.
- Ce produit n' est pas destiné à être utilisé à l' extérieur.
- Ne le placez pas sur ou à proximité d' une cuisinière électrique ou d' un four chaud.
- N' utilisez pas l' appareil électrique à d' autres fins que celles pour lesquelles il a été conçu.

IMPORTANT INSTRUCTION

— ATTENTION

- Ce produit est conçu pour un usage domestique uniquement. Le fabricant n' accorde de garantie que pour les défauts de fabrication et les pannes résultant d' une utilisation domestique. Le fabricant n' est pas responsable des conséquences ou des défaillances causées par une utilisation commerciale, une utilisation inadéquate ou le non-respect des instructions. Ces défauts et dommages ne sont pas couverts par la garantie.
- Avant d' utiliser le produit, vérifiez que la tension indiquée sur l' étiquette de spécification du produit correspond à la tension principale.
- Ce produit doit être utilisé avec la base correspondante. N' utilisez pas d' autre base.
- Placez toujours la bouilloire électrique sur un plan de travail plat, stable et résistant à la chaleur.
- Avant d' utiliser le produit, assurez-vous que le couvercle supérieur est correctement fermé. Autrement, il y a risque de brûlure.
- Pendant son fonctionnement, la bouilloire électrique génère des températures élevées et de la vapeur. N' ouvrez pas le couvercle de la bouilloire. Ne touchez pas et ne déplacez pas la bouilloire électrique et ne vous approchez pas de la sortie de vapeur et d' autres parties à haute température. Autrement, il y a risque de brûlure.
- Ne chauffez pas un récipient hermétique dans la bouilloire. Autrement, il y a risque d' explosion.
- N' utilisez pas la bouilloire lorsque le niveau d' eau est supérieur au niveau maximum ou inférieur au niveau minimum. Si vous remplissez la bouilloire électrique avec trop d' eau ou d' ingrédients, de l' eau bouillante risque de jaillir hors de l' appareil. Si vous la remplissez avec trop peu d' eau ou d' ingrédients, le fond de l' appareil risque de brûler ou de chauffer à sec.
- Gardez la bouilloire à l' abri de l' humidité et du gel. Ne mettez pas la bouilloire au réfrigérateur.
- Le K1563 utilise des boutons tactiles. Si le produit est en mode veille après avoir été mis sous tension, il est normal que les boutons tactiles se déclenchent lorsqu' ils sont essayés avec un chiffon humide, ce qui n' affecte pas l' utilisation normale.
- Pour éviter tout risque d' électrocution ou d' incendie, veillez à débrancher l' appareil dans les circonstances suivantes : 1) lorsque la bouilloire est vide ; 2) lorsque la bouilloire électrique n' est pas utilisée ; 3) lorsque vous nettoyez ou déplacez la bouilloire électrique ; 4) lorsque des pièces de la bouilloire électrique sont endommagées ; ou 5) lorsque la bouilloire électrique ne fonctionne pas correctement.
- Il est recommandé de vider la bouilloire électrique si elle n' est pas utilisée pendant longtemps.

IMPORTANT INSTRUCTION

- Si vous devez débrancher la fiche, tenez-la avec les mains et tirez-la. Ne tirez pas le cordon d' alimentation et ne le tordez pas de force. Cela pourrait endommager le cordon d' alimentation, ce qui entraînerait un risque de fuite électrique.
- Le cordon d' alimentation ne doit pas dépasser le bord de la table ou de la surface du plan de travail. Dans une telle situation, la bouilloire électrique risque de tomber ou de provoquer des risques de trébuchement.
- Ne détartrez pas la bouilloire électrique avec d' autres méthodes qui ne sont pas recommandées. Pour les méthodes recommandées, veuillez vous référer aux instructions de nettoyage dans les sections suivantes.
- Il est conseillé d' utiliser de l' eau purifiée. Pour éviter tout dysfonctionnement de la plaque chauffante dû à une accumulation excessive de tartre, veuillez nettoyer régulièrement le tartre sur l' élément chauffant.
- Si les composants de la bouilloire électrique sont endommagés ou ne fonctionnent pas correctement, débranchez immédiatement la fiche d' alimentation. Ne l' utilisez pas et ne la démontez pas vous-même. Veuillez vous rendre dans un centre de service agréé par BUYDEEM pour un remplacement ou une réparation.
- Toute autre utilisation et opération que le nettoyage et le détartrage normaux précisés dans le manuel doit être effectuée par un centre de service autorisé par BUYDEEM.
- Aucun dysfonctionnement ou défaut de fonctionnement causé par un manque de nettoyage et de détartrage de la bouilloire électrique n' est couvert par la garantie.
- Tous les produits sont fabriqués conformément à la procédure de contrôle de la qualité, y compris les tests d' utilisation réelle de produits sélectionnés au hasard, qui expliquent toute trace d' utilisation sur les produits.
- Si le cordon d' alimentation est endommagé, il doit être remplacé par un professionnel désigné par le fabricant, de son service après-vente ou d' un service similaire afin d' éviter tout danger.

Veillez conserver ces instructions.

PRODUCT OVERVIEW

— STRUCTURE

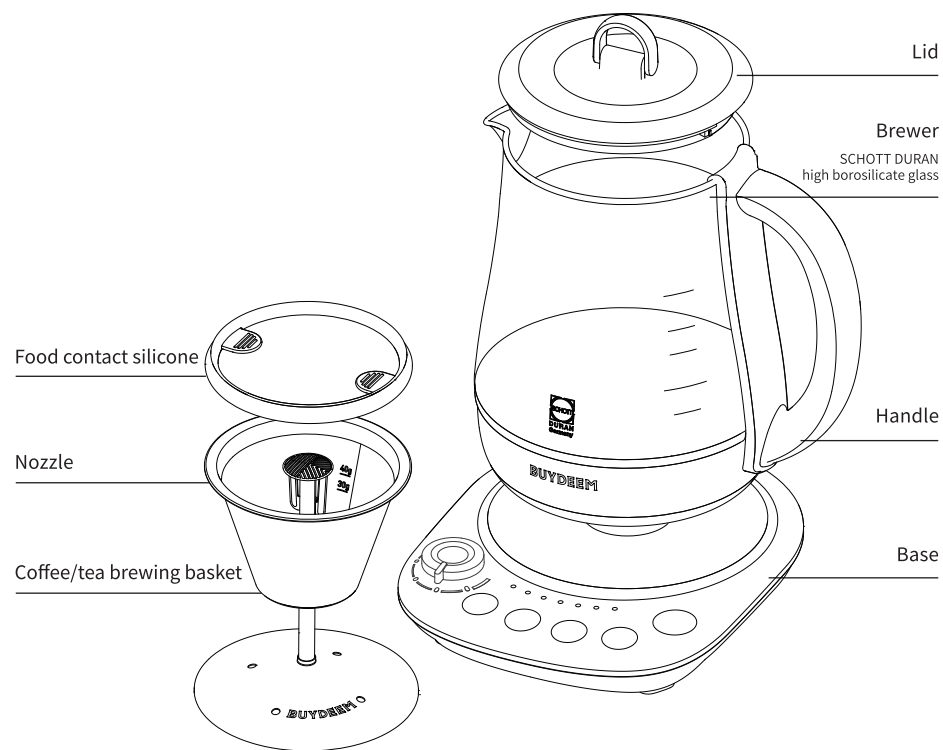

PRODUCT OVERVIEW

— MODE INTRODUCTION

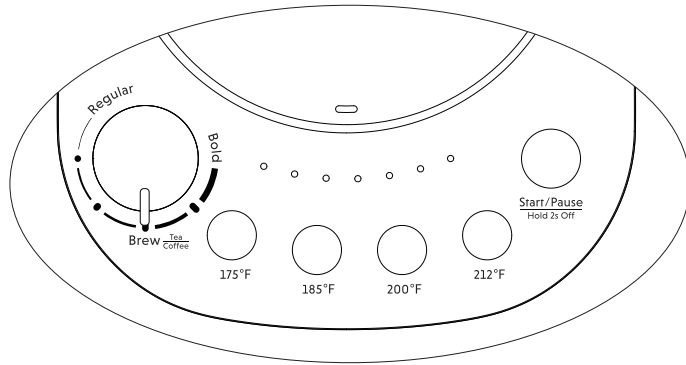

Function Type	Function Name	Suitable Ingredients	Function Operation Modes	Automatic Keep-warm
Boil Water	175°F	Water	Quickly boil water to 175°F.	175°F, 2H
	185°F		Quickly boil water to 185°F.	185°F, 2H
	200°F		Quickly boil water to 200°F.	200°F, 2H
	212°F		Quickly boil water to 212°F.	158°F, 2H
Brew (Need to use the coffee/tea brewing basket)	Brew tea	Black tea, oolong, dark tea, white tea, etc.	Turn the knob to select the desired taste from 6 different tastes ranging from regular to bold. After the water is boiled, the tea/coffee brewing mode will start.	158°F, 120min
	Brew coffee	For medium/dark roast coffee beans, select the medium level of grinding.		158°F, 120min
Manual Keep-warm	Keep warm for 8 H	/	Long press “212°F” for 2 seconds, and the breathing mode of the knob light ring will be activated. Then press the Start button to keep warm for 480 minutes at a temperature of 158°F.	/

PRODUCT OVERVIEW

— LIGHTNING PROGRESS BAR

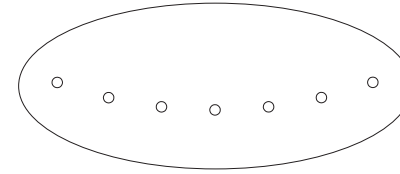

When the electric steam brewer starts brewing, the lights on the light bar will gradually turn on from left to right as the brewing function proceeds. Users can monitor the brewing progress by observing the status displayed by the lights.

Function Name	Lightning Progress Bar
Boil Water	The light bar shows the temperature change in the brewer.
Brewing	The light bar shows the temperature change and the progress of the brewing time. When the first light turns on, it indicates that the water in the brewer has reached boiling point. The remaining 6 lights represent the progress of time.
Keep-warm	When the electric steam brewer is in the keep-warm status, the lights will turn off.

PRODUCT OVERVIEW

— DESIGN OF COMPONENTS

Introduction to the Coffee/Tea Brewing Basket

- To make it easier for users to brew tea and coffee with steam, a coffee/tea brewing basket is designed for the electric steam brewer.
- When brewing tea, the coffee/tea brewing basket can separate the tea leaves and the water, which can prevent the tea from becoming bitter due to over-soaking.
- When brewing coffee, multiple servings can be brewed at once, making it convenient for sharing.
- When using the electric steam brewer with the coffee/tea brewing basket, select the tea brewing or coffee brewing function according to the ingredients. Next, select the taste and start brewing.
- Please make sure the lid is closed during the brewing process. Otherwise, it might lead to the risk of scalding caused by the splash of water.

Operating Instructions



- Add an appropriate amount of water to the electric steam brewer. Please control the amount of water between 500 ml to 750 ml.

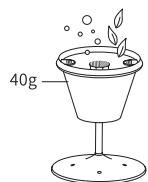

- After putting the coffee powder/tea leaves into the coffee/tea brewing basket, place the basket into the electric steam brewer filled with water. (Note: Please do not exceed the 40 g marking line when adding coffee powder.)

PRODUCT OVERVIEW

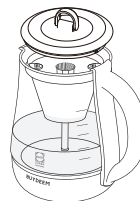

- Close the brewer lid tight. Select the 【Tea/Coffee Brewing】 function according to the ingredients, turn the knob to select the taste, and press the “Start” button to begin brewing.



- After the tea/coffee brewing process is completed, directly pour it into a cup to enjoy.
CAUTION: To take out the coffee/tea brewing basket, please hold the silicone handle.

CAUTION!

The K1563 brewer must be used together with the K1563 power cord base. Do not use the K1563 with other models of BUYDEEM products or with products of other brands. Otherwise, it may result in boiling failure, brewing failure, or other risks, such as short circuits or electric shocks.

— INITIAL USE



1. Remove all the packaging inside and outside the electric steam brewer.
 - A boiling point measurement is recommended before you use the product for the first time. For specific operating instructions, please refer to Boiling Point Measurement in the following sections.

OPERATING INSTRUCTIONS

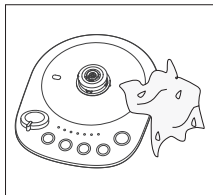

2. Pour off the water from the second or third time of boiling for cleaning purposes. Wipe the surface of the components of the electric steam brewer with a dry cloth (please be noted that the bottom of the brewer and the electrical connector on the base should not be exposed to water).

— OPERATING INSTRUCTIONS

Boiling Water



1. Open the brewer lid.



2. Add an appropriate amount of purified water.

- When the electric steam brewer is on the base, please do not add water.
- Do not add water above the maximum or below the minimum water level line.
- Adding water above the maximum water level line might cause a splash of water when the water is boiling.

OPERATING INSTRUCTIONS



3. Close the brewer lid tight.

- Put the brewer lid on the brewer as instructed in the picture. Please ensure that the spout filter is aligned with the spout. Gently press the lid to close it tight. Try to gently lift the lid with your hand. If you cannot lift it, then the lid is properly closed.
 - If the lid is not properly closed, it may easily drop off when pouring water.
-



4. Put the electric steam brewer on the base.

- Please wipe the bottom of the brewer and the surface of the base dry.
 - Please place the base on a flat, clean, and heat-resistant surface.
 - The electric steam brewer must be used together with its matching base.
 - Please do not use the electric steam brewer when there is no water in it.
-

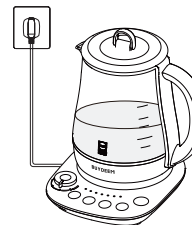

5. Plug in power.

- After powering on, the buzzer will sound. The button light will flash and go off, which indicates that the standby mode has been activated, and you can select the function.

Brewing

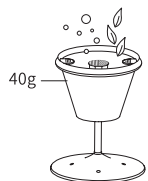

1. Add tea leaves or coffee powder to the coffee/tea brewing basket.



2. Add an appropriate amount of purified water.

- Add water to the electric steam brewer between the 500 ml and 750 ml water level line (the water level before placing the coffee/tea brewing basket).
- When the electric steam brewer is on the base, please do not add water.



3. Put the coffee/tea brewing basket into the brewer and close the brewer lid tight.

- Please make sure the silicone ring on the coffee/tea brewing basket is properly assembled.



4. Put the electric steam brewer on the base.

- Please wipe the bottom of the brewer and the surface of the base dry.
- Please place the base on a flat, clean, and heat-resistant surface.
- The electric steam brewer must be used together with its matching base.
- Please do not use the electric steam brewer when there is no water in it.

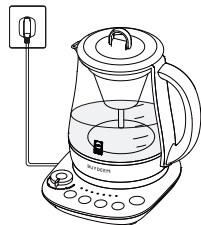

5. Plug in power.

- After powering on, the buzzer will sound. The button light will flash and go off, which indicates that the standby mode has been activated, and you can select the function.

— OPERATING INSTRUCTIONS OF FUNCTIONS

Operating Instructions of Boiling Water Function

Step 1: Select any button shown in the picture (left), for example, the “212°F” button.

Step 2: Press the “Start/Pause” button, and the corresponding function mode will be activated.

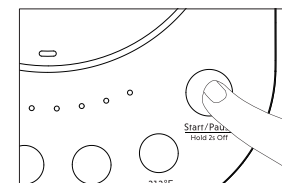
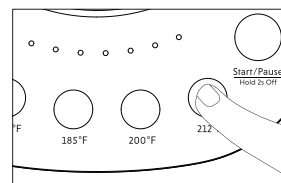

Operating Instructions for Manual Keep-warm Function

Step 1: Long press the “212°F” button for 2 seconds, and the breathing mode of the light ring will be activated.

Step 2: Press the “Start/Pause” button to activate the Keep-warm mode.

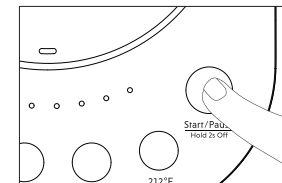
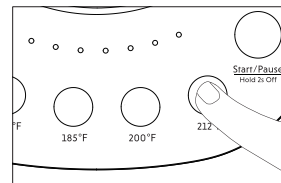

Operating Instructions for Tea/Coffee Brewing Function

Step 1: Rotate the knob until the pointer is aligned with the selected taste.

Step 2: Press the “Start/Pause” button to activate the corresponding brewing mode.

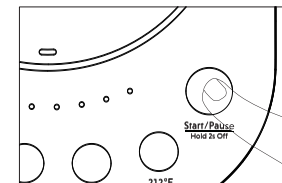
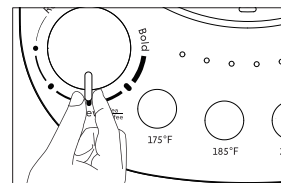

BOILING POINT MEASUREMENT

— BOILING POINT MEASUREMENT AND MEMORY PROGRAM

- At high altitudes, the boiling point of water cannot reach 100°C, which makes it difficult for the electric steam brewer to operate normally (it takes too long for the brewer to shut off upon boiling, or the shut-off may fail).
- BUYDEEM suggested that you should always conduct a boiling point measurement when you use the electric steam brewer for the first time. When the measurement is done, the chip will record the data of specific boiling points. There is no need to measure it again when you use the electric steam brewer later.
- After the boiling point measurement, the electric steam brewer can operate more accurately (the performance will become better than in the factory setting).
- If you live in a city at an altitude of over 250 meters, please make sure you conduct a boiling point measurement before using the product.

— START BOILING POINT MEASUREMENT

1. Add water to the 1200 ml water level line. Too much or too little water can affect the measurement results.

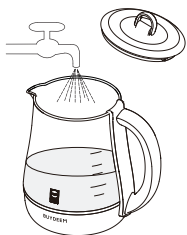

2. Put it on the power cord base and power it on. The knob light will flash and go off, which indicates that the standby mode has been activated.

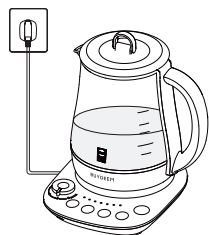

BOILING POINT MEASUREMENT

3. Long press the “200°F” button for 2 seconds, the “Start/Pause” button will flash, and the light ring around the “200°F” button will go off. Do not release your finger before hearing a short beep sound generated by the device.

Note: After powering on, you need to press the “200°F” first for 2 seconds. Otherwise, the boiling point measurement cannot be activated.

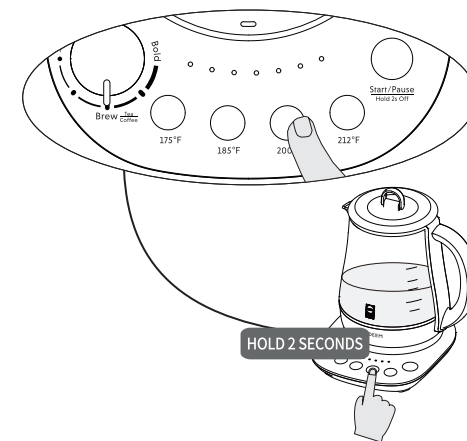

4. Press the “Start/Pause” button. All the button lights will alternately flash.

Now the device has started the measurement. After the measurement is completed, the device will generate 3 long beeps, automatically stop operating and enter standby mode.

Note: To conduct the boiling point measurement again, please reconnect the power supply.

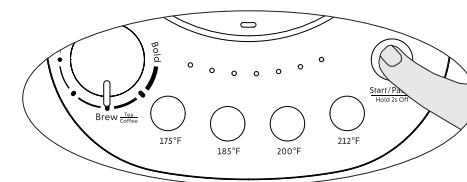

— MEMORY FUNCTION

- When the electric steam brewer is operating according to the program, you can pause it by lifting the brewer or pressing the “Start/Pause” button. If you put the brewer back or press the “Start/Pause” button again within 1 hour after the program is paused, the electric steam brewer will continue the unfinished program without running the whole function program again.

— PREVENT MISOPERATION

▪ You can rotate the knob or press the function buttons to switch the function within 1 minute after the electric steam brewer starts operating. To prevent misoperation, if the electric steam brewer has started operating for more than 1 minute, the selected function cannot be switched freely. To switch the function, you need to press the “Start/Pause” button first. After the “Start/Pause” button starts to flash, you can select the function to switch.

— PREVENT COLD WATER RISK

▪ If cold water is added when the electric steam brewer is operating, the brewer will automatically reboil the water and then continue the unfinished program, so there is no need to worry about any health risks due to the addition of cold water.

— CLEANING AND MAINTENANCE

Cleaning of Electric Steam Brewer

- Unplug the power plug.
 - After the brewer cools off, clean the inside of the electric steam brewer with a damp sponge.
 - CAUTION: Do not immerse the electric steam brewer, base, power cord, or plug in water (the bottom of the brewer and the electrical connector on the base should not be exposed to water).
- Please clean the brewer in time after each use to avoid food spoilage.

Descaling

- The electric steam brewer needs to be descaled regularly, at least once a month. If the water quality is poor, the frequency should be increased accordingly.
- If there are spots on the heating plate, it is caused by limescale, which is a normal phenomenon. You can gently clean it with a scouring pad. If there is too much limescale, you can descale the brewer with the following methods.

Electric Steam Brewer Descaling Tips

Use white vinegar:

- Add 100 ml of white vinegar to the electric steam brewer.
- Add water to the electric steam brewer to the 500 ml marking line.
- Activate the “212°F” function program.
- After the program is completed, let the brewer sit for 1 hour and wipe the bottom of the brewer clean with a scouring pad.

Use citric acid:

- Add 500 ml of clean water to the electric steam brewer.
- Add 10 g of citric acid.
- Activate the “212°F” function program.
- After the automatic shut-off, let the brewer sit for 5 to 10 minutes. (If there is much limescale, let the brewer sit for a longer time.)

Finally, pour off the water in the brewer and wipe the bottom of the brewer clean with a scouring pad.

Cleaning of Coffee/Tea Brewing Basket

- Unplug the power plug.
- After the brewer cools off, take out the basket by holding the silicone handle. Do not directly hold the nozzle. Otherwise, it might lead to the risk of scalding.
- Use a small BUYDEEM cleaning brush to dip some BUYDEEM BIO-Star cleaning paste, and rinse it off with water. The coffee/tea brewing basket can be cleaned in a dishwasher.
- Put the filter upside-down after cleaning it. Dry it in a ventilated place.
- Note: The coffee/tea brewing basket can be put into a sterilization cabinet, but the silicone ring needs to be removed, as the UV and ozone inside the sterilization cabinet can affect the lifespan of the silicone.

— BASIC TROUBLESHOOTING

Problem	Possible Causes	Troubleshooting
After installation, there is no sound prompt, and the button light does not turn on	No power supply	Check if the socket is plugged in.
	The brewer is not properly connected to the base	After putting the brewer on the power cord base, rotate the brewer or adjust it to make sure it is properly connected.
	Power cord base failure	Contact the after-sales service center.
The prompt sound keeps ringing	Dry burn protection (usually, all button lights will turn on)	Cool down for a few minutes before adding cold water and continuing to use it.
	Abnormal NTC	Contact the after-sales service center.
5 short beeps of prompt sound are generated consecutively	The temperature of water in the brewer is too high	The temperature of water in the brewer is higher than the target temperature set by the program. Add cold water and try again.
Odor in water	Unused new electric steam brewer	Before using the new electric steam brewer, it is suggested to pour off the water from the first few times of boiling. If the odor in the water still exists, add water to the maximum water level line and add 2 teaspoons of soda. Pour off the water after boiling it and clean the electric steam brewer.
Dry burn alarm	The water in the brewer has boiled dry	Cut off the power supply and add enough cold water to the brewer.
The base is operating normally, but the brewer stops heating up	It might be caused by the poor contact resulting from water entering the electrical connector on the base	Contact the after-sales service center.

— WARRANTY AND SERVICE NOTE

- If the product has obvious damage, please contact the BUYDEEM customer service center or send it to the service sites for repair.
- The warranty only covers product defects and damages caused by proper use in accordance with the user manual. Repair fees will be charged for damage caused by improper use or other non-product quality issues.
- Customers who need to purchase product parts beyond the warranty period can contact the after-sales service center of the purchasing channel.

The following cases are not eligible for free repairs:

- No warranty card or valid invoice is provided.
- Malfunction caused by failure to follow the instructions in the user manual.
- Damage caused by improper use, storage, and maintenance.
- Damages caused by repairs conducted by any party other than the designated repair centers by the company.
- Damages caused by force majeure.

For the benefit of customers, BUYDEEM reserves the right to make modifications to product features and components to ensure the proper use of the product.

If you need more services and information or have any questions, please contact the after-sales service center.

Warranty Card		BUYDEEM	
Dear customer, Thank you so much for buying BUYDEEM products! This product comes with a one-year warranty. Please prepare the following information when contacting us in case you need the warranty service.			
Model:		Name:	
Factory serial number:		Order date:	
Order number:			
Customer name:		Customer phone number:	
Customer email address:			
If you have any questions or queries, please feel free to email us.			

感谢您购买北鼎产品,为了能让您充分享受北鼎全方位的支持,使用本产品之前请仔细阅读本说明书及相关图解。

目录 CONTENTS

注意事项	/ 23-24
技术规格	/ 25
认识产品	/ 26-28
使用产品	/ 29-32
沸点检测	/ 33
特色功能	/ 34
清洁和保养	/ 35
简单故障处理	/ 36
保修和服务	/ 37

BUYDEEM 北鼎

使用电器时,应始终遵循基本的安全预防措施,包括以下内容:

阅读所有说明。

— 危险

- 切勿在无人看管的情况下运行本产品,以防产品突发情况造成火灾等危险。
- 不要接触高温表面。请使用把手。
- 为防止触电或短路等危险,切勿将蒸汽萃取壶、底座、电源线及插头置于水中或其它任何液体中。



— 警告

- 儿童、老年人、肢体或精神能力受限人士及无使用经验人士应在监督和指导下使用产品,并保证其安全。严禁儿童在无人看管的情况下接触本产品,以免将本产品当作玩具玩耍。
- 本产品必须单独使用额定电流10A以上,额定电源120V~ 60Hz的接地插座,插头需完全插入插座,以防接触不良而导致元件过热烧坏,引发短路或火灾等危险。切勿使用万能插座。
- 请将蒸汽萃取壶和电源线远离高温、明火、潮湿、光滑的台面或锋利的边缘,以防引起器件损坏、故障或火灾。
- 手沾水或赤脚时禁止使用蒸汽萃取壶。
- 请勿在室外使用。
- 请勿放置在热气或电炉上或附近,或放在加热的烤箱中。
- 请勿将电器用于规定用途以外的用途。

— 注意

- 本产品仅设计为家庭使用,厂商仅对生产瑕疵和家用故障进行保修;任何商业用途、不适合用途或未遵照说明操作而造成的后果与故障,厂商均不负任何责任,此等故障损坏均不属于保修范围内。
- 使用前请核对产品规格标贴上显示的电压与主电压是否一致。
- 本产品必须和其配套的底座一起使用,请勿使用其它底座。
- 请始终将蒸汽萃取壶放置在平坦、稳固、耐热的工作台上。

— 注意

- 使用产品前,请务必确认上盖已正确盖好,以防烫伤。
- 蒸汽萃取壶在工作期间会产生高温和蒸汽,请勿在工作期间揭开壶盖、触碰或移动蒸汽萃取壶、靠近蒸汽出口等高温部分,以防烫伤。
- 请勿将密闭的容器放置在壶内加热,以防产生爆炸的危险。
- 请勿在超过最大水位或低于最低水位的情况下运行蒸汽萃取壶;蒸汽萃取壶内装水或食材过满,可能会引起沸水溅出,蒸汽萃取壶内装水或食材过少,可能会引起干烧或糊底。
- 蒸汽萃取壶要防潮、防冻,请勿将蒸汽萃取壶放进冰箱。
- K1563为触控按键,在通电待机的情况下,如用湿抹布擦拭,有可能会触发功能按键,此为正常现象,不影响正常使用。
- 为防止触电或火灾,请保证下列情况下电源是断开的:空壶时、不使用蒸汽萃取壶时、清洁或移动蒸汽萃取壶时、蒸汽萃取壶部件损坏时、当蒸汽萃取壶出现故障时。
- 如果长时间不使用蒸汽萃取壶,建议将蒸汽萃取壶内的水倒掉。
- 如需拔下插头,请手握住插头再拔出,请勿强行拉扯或扭曲电源线,以防电源线损坏,产生漏电危险。
- 请不要让电源线悬挂在桌子或工作台面边缘之外,以防蒸汽萃取壶摔落,或引起绊倒。
- 请不要用非推荐的方法除水垢,推荐方法详见后文清洁说明。
- 建议使用纯净水烹饪。避免因水垢过多导致发热盘故障,请定期清洗发热体上的水垢。
- 如发现蒸汽萃取壶部件损坏或不能正常工作时,请立即拔掉电源插头,切勿继续使用,也请勿自行拆除,请联系北鼎授权的服务中心进行更换或维修。
- 除了按照说明书进行清洁和除垢,其它任何非正常使用操作必须由北鼎授权的服务中心进行。
- 由于未对蒸汽萃取壶进行除垢造成其不能正常使用或完全不能使用的情况,不属于保修范围。
- 因为所有产品均严格按照质量控制程序,其中包括对随机抽检产品的实际使用测试,所以其将对产品的任何使用痕迹作出解释。
- 如果电源线损坏,为了避免危险,必须由制造商、其维修部或类似部门的专业人员更换。
- 分线说明:
 - a) 该产品配备短电源线以降低因被较长电源线缠绕或绊倒而导致的风险。
 - b) 可以使用延长线,但在使用时要注意。
 - c) 如果使用延长线:
 - 1) 延长线标示的电气额定值应至少与电器的电气额定值一样大;
 - 2) 该产品为接地型,延长线需使用接地型的三芯线;
 - 3) 较长的线缆应妥善布置,不可悬垂在台面或桌面上,以免被儿童拉扯或绊倒。

请保存这些说明。

— 技术规格

产品名称	蒸汽萃取壶		产品型号	K1563	
产品功率	1000W	最大容量	1.5L	电压	120V~ 60Hz

本产品采用食品接触用材质：

食品接触用德国肖特高硼硅玻璃、SUS304 (06Cr19Ni10)及 SUS316L (022Cr17Ni12-Mo2) 不锈钢、聚丙烯PP塑料、食品接触用硅胶

— 产品结构图

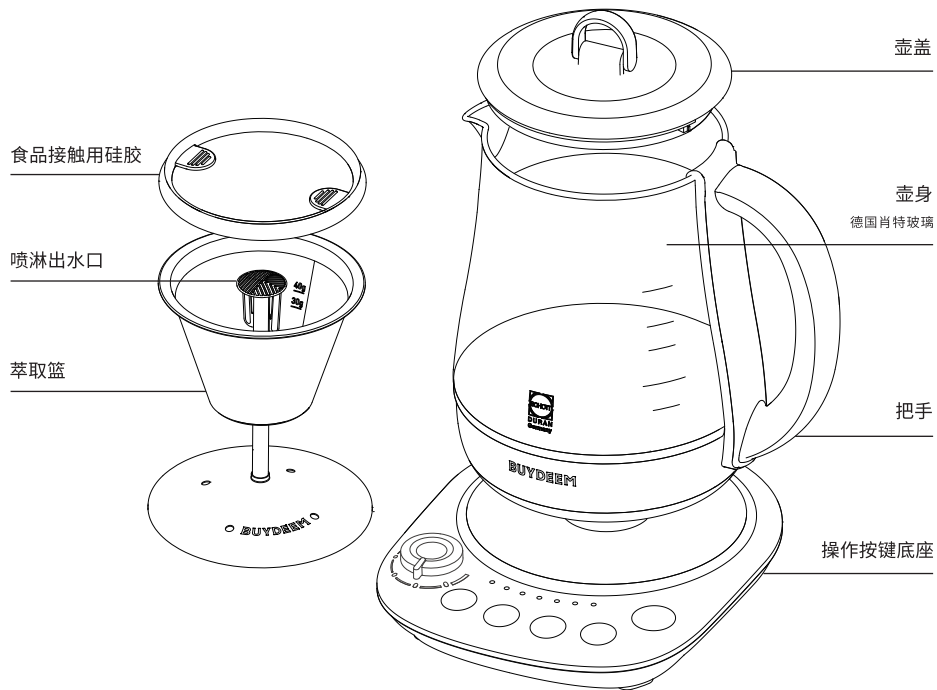

— 功能模式介绍

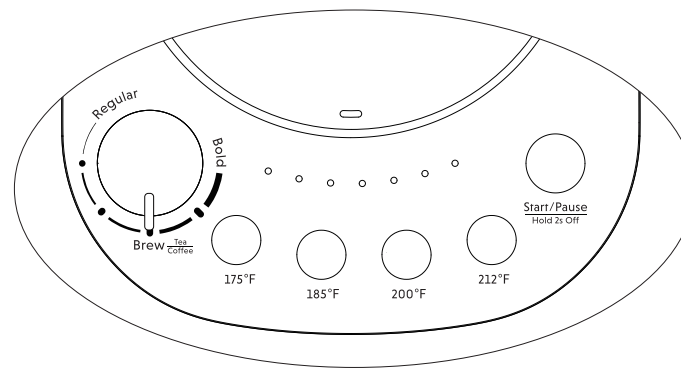

功能类型	功能名称	适煮食材	功能运作方式	自动保温
烧水	175°F	水	快速烧水至175°F。	175°F, 2小时
	185°F		快速烧水至185°F。	185°F, 2小时
	200°F		快速烧水至200°F。	200°F, 2小时
	212°F		快速烧水至212°F。	158°F, 2小时
萃取 (需搭配萃取篮使用)	萃取茶	红茶、乌龙、黑茶、白茶等	旋转旋钮，从淡到浓共6个口感中，选择喜欢的最佳口感；水烧开后按照萃取茶&咖啡模式工作。	158°F, 120分钟
	萃取咖啡	中烘或者深烘咖啡豆，选择中研磨度		158°F, 120分钟
手动保温	保温8小时	/	长按“212°F”2秒，按键灯圈进入呼吸模式，再按下开始键，即会以158°F保温480分钟。	/

— 灯带进度条

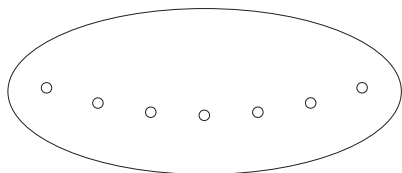

- 当蒸汽萃取壶启动烹煮程序时，灯带会从左到右随着烹煮功能的完成进度逐渐亮起灯源，用户可以通过灯源显示状态判断烹煮进度。

功能名称	灯带进度条运作方式
烧水	灯带代表壶内温度完成情况。
萃取功能	灯带代表的是温度和烹煮时间的进度。 第一颗灯亮起时，代表壶内水已是烧开状态，剩余的6颗灯代表时间的进度。
保温	蒸汽萃取壶处于保温状态时，灯源熄灭。

— 部件设计

萃取篮介绍

- 为方便用户蒸汽萃茶和萃煮咖啡，蒸汽萃取壶引入了萃取篮的独特设计。
- 蒸汽萃茶时，萃取篮能使茶水分离，防止茶叶因过度浸泡而产生苦涩感。
- 萃煮咖啡时，能一次萃取多人份咖啡，方便分享。
- 萃取篮搭配北鼎蒸汽萃取壶使用时，根据食材选择萃取茶&咖啡功能，选择对应的口感后开始烹煮。
- 烹煮时，请务必关盖，防止喷溅，避免烫伤。

操作指引

- 在蒸汽萃取壶内加入适量的水。水量请控制在500ml-750ml之间。



- 盖紧壶盖。根据食材选择【萃取茶/咖啡】功能，旋转旋钮选择对应的口感后，按“键开始烹煮”。

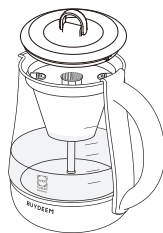

注意!

必须配套使用K1563壶身及K1563线座，切勿将其他品牌产品或北鼎其他型号产品与K1563混用，否则可能出现无法正常烧水或烹煮的情况，甚至出现短路、触电等危险。

- 将咖啡粉/茶叶放入萃取篮后，再将萃取篮放入装好水的蒸汽萃取壶内。

注意：咖啡粉请勿超过40g刻度线。

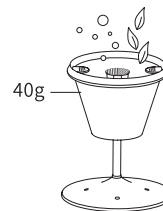

- 烹煮完成后，可直接倒入杯中享用。
- 注意：如需拿取萃取篮，请通过硅胶提手拎出。

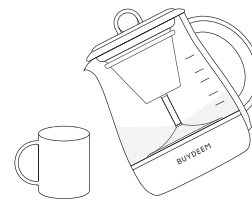

— 初次使用

1. 去除蒸汽萃取壶内外所有包装。

- 在初次使用产品之前，我们建议您做一次沸点检测。操作方式请见后文沸点检测部分。

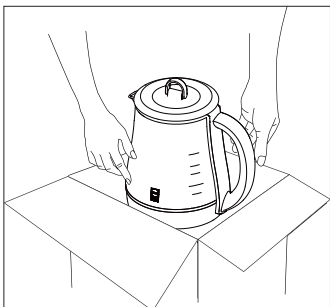

2. 前2-3次煮水应该倒掉用于清洁，然后用干布擦拭蒸汽萃取壶部件的外部(请注意壶底和底座上的电子连接器不可接触水)

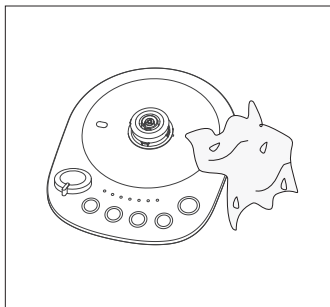

— 使用指引

烧水功能



1. 打开壶盖



2. 加入适量纯净水

- 当蒸汽萃取壶在底座上时请勿加水。
 - 切勿加水超过最大水位或低于最小水位。
- 若加水过满，沸腾时可能会溅出水。



3. 盖紧壶盖

- 将壶盖按图示位置放在壶身上，请确认壶嘴滤网是否对准壶嘴，轻轻按压使壶盖合紧，用手轻轻提起，若提不起，表示盖子合紧。
- 如盖子装配不到位，倒水时，盖子容易掉下来。

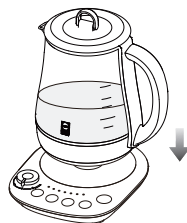

4. 将蒸汽萃取壶放在底座上

- 请将壶底及底座面上的水擦干。
- 底座务必放置在平坦、干净的耐热台面上。
- 蒸汽萃取壶壶身必须使用专属的底座。
- 蒸汽萃取壶内无水时请勿使用。

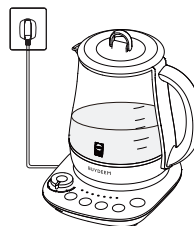

5. 插上电源

- 当蒸汽萃取壶通电，蜂鸣器发出响声，按键灯闪烁后灯灭，表示进入待机状态，可开始选择功能工作。

萃取功能

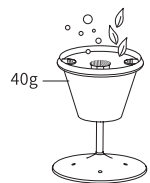

1. 在萃取篮里加入茶叶或者咖啡粉。



2. 加入适量纯净水

- 加水至蒸汽萃取壶刻度500mL-750mL之间(放萃取篮前水位)
- 当蒸汽萃取壶在底座上时请勿加水。



3. 把萃取篮放入壶内，盖紧壶盖

- 请注意确认萃取篮上的硅胶圈是安装好的。



4. 将蒸汽萃取壶放在底座上

- 请将壶底及底座面上的水擦干。
- 底座务必放置在平坦、干净的耐热台面上。
- 蒸汽萃取壶壶身必须使用专属的底座。
- 蒸汽萃取壶内无水时请勿使用

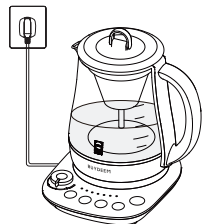

5. 插上电源

- 当蒸汽萃取壶通电，蜂鸣器发出响声，按键灯闪烁后灯灭，表示进入待机状态，可开始选择功能工作。

— 功能模式使用指引

烧水功能使用指引

step1: 选择左图中任一按键，如“212°F”按键

step2: 按“开始/暂停”按键，即可开始对应功能模式

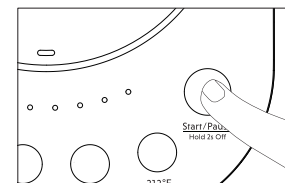
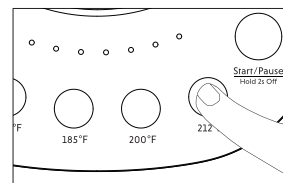

手动保温功能使用指引

step1: 长按“212°F”按键2秒，灯圈进入呼吸状态

step2: 按“开始/暂停”按键，即可开始保温模式

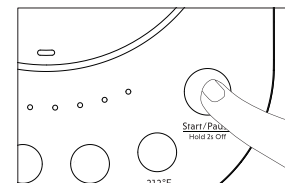
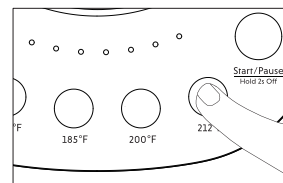

萃取茶/咖啡功能使用指引

Step 1: 旋转旋钮，旋钮指针对准选定的口感

step 2: 按“开始/暂停”按键，即可开始对应萃取功能模式

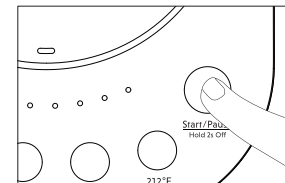
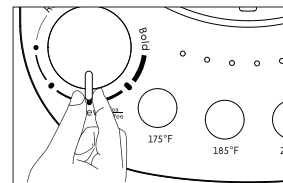

一 沸点检测记忆程序

- 由于在非零海拔地区，水在沸腾时无法达到100°C，这可能导致蒸汽萃取壶无法正常工作（跳过过慢甚至无法正常跳断）。
- 北鼎建议您在第一次使用时，均进行一次沸点检测操作。检测完成后，芯片将记录精确沸点数据，再次使用无需重复检测。
- 经过沸点检测后，蒸汽萃取壶能更精准地工作（性能比出厂设置时更佳）。
- 若您处于海拔高于250m的城市，请务必进行沸点检测操作后再使用。

一 启动沸点检测

1. 加水至1200ml水位线，水量不足或过多时，会影响检测结果。

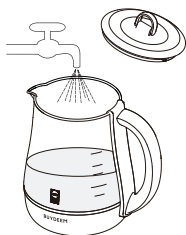

2. 放入线座，并通电。按键灯闪烁后灭灯，进入待机状态。

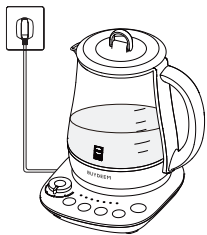

3. 长按“200°F” 按键2秒，“开始/暂停” 按键闪烁，“200°F” 按键灯圈熄灭。听到机器短鸣一声后，方可松开手指。

备注：通电后，需首先按下 “200°F” 按键2秒，否则无法启动沸点检测。

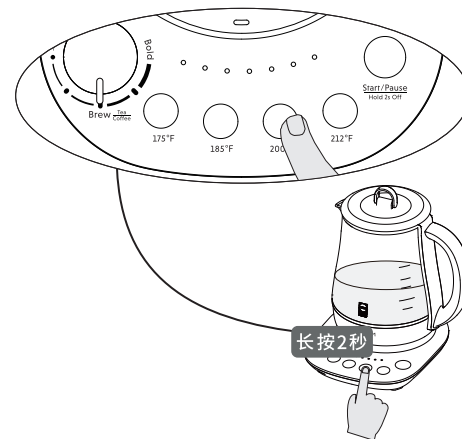

4. 按一下 “开始/暂停” 键，所有按键指示灯轮番闪烁。

此时机器已进入检测状态。检测完成后机器长鸣三声，自动结束工作并进入待机状态。

备注：如需再次进行沸点检测，请重新接通电源。

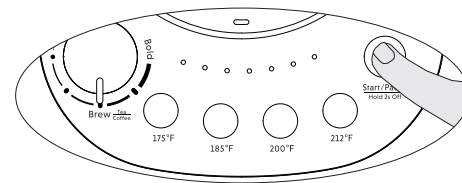

一 壶暂停记忆功能

- 蒸汽萃取壶按照程序进行工作时，可通过提壶或按“开始/暂停”来使其暂停工作，暂停1个小时内再通过放壶或按“开始/暂停”来开始工作，蒸汽萃取壶将执行暂停前未完成的程序时间，不会重新执行一遍功能程序。

一 避免误操作

- 蒸汽萃取壶开始工作的1分钟内，可以通过拨动旋钮或触摸功能按键来切换功能。为了避免误操作，蒸汽萃取壶开始工作1分钟后，不能随意切换功能。若需要切换功能，需先按“开始/暂停”按键，“开始/暂停”按键闪烁，再选择需要切换的程序。

一 冷水保护

- 蒸汽萃取壶工作时，如在烹煮中途加入冷水，蒸汽萃取壶会自动重新将水烧开后再执行未完成的程序，无需担心生冷隐患。

— 清洁和保养

蒸汽萃取壶的清洗

- 拔下电源插头。
 - 待水壶冷却后，用湿海绵清洗蒸汽萃取壶内部。
 - 注意：切勿将蒸汽萃取壶、底座、电源线或插头浸泡水中(壶底及底座上的电子连接器不可接触水)。
- 每次使用后，为避免食物变质，请及时清洗。

除水垢

- 蒸汽萃取壶需定期除水垢，至少每月一次，如水质较差则应增加次数。
- 发热盘如出现斑点，此为水垢，属于正常现象，用百洁布轻轻擦洗即可清洗干净。若情况较为严重，可采用以下方式除垢。

蒸汽萃取壶除垢小贴士

使用白醋：

- 往蒸汽萃取壶内加入100ml白醋。
- 往蒸汽萃取壶内加水至500ml刻度线。
- 启动“212°F”功能模式。
- 程序结束后，静置1小时，然后用百洁布将壶底擦净即可。

使用柠檬酸：

- 往蒸汽萃取壶内加入500ml清水。
- 加入10g柠檬酸。
- 启动“212°F”功能模式。
- 待自动断电后，静置5-10分钟。（若水垢较多，可延长静置时间）

最后将壶内水倒掉，用百洁布将壶底擦净即可。

萃取篮的清洗

- 拔下电源插头。
- 待水壶冷却后，通过硅胶提手取出，切勿直接提拿喷淋头，避免烫伤。
- 使用北鼎小清洁刷蘸取北鼎BIO-Star清洁膏，然后用水冲洗干净。萃取篮可进洗碗机清洗。
- 滤网清洗后请倒置，在通风处晾干。
- 注意：萃取篮可以进消毒柜，但需要移除硅胶圈，因为消毒碗柜内的紫外线、臭氧会影响硅胶的使用寿命。

— 简单故障处理

故障现象	原因分析	故障排除
安装后， 无提示声音且按键灯不亮	未接通电源	检查插座是否已插好
	煲身与底座没有连接到位	煲身放上线座后，可旋转或调整位置，确认已连接到位
	线座故障	联系售后处理
提示音持续响	干烧保护（一般按键灯全亮）	冷却数分钟后，再倒入冷水继续使用
	NTC异常	联系售后处理
连续5声提示音短鸣	壶内水温过高	壶内水温高于设定程序目标水温，可以加入冷水后再重试。
水有异味	未使用过的新蒸汽萃取壶	新蒸汽萃取壶使用前建议煮几次水倒掉，如果状况持续发生，将水注满至最高水位，并加两茶匙的苏打，煮沸后倒掉，再清洗蒸汽萃取壶。
干烧报警	壶内水已烧干	断开电源并在壶内加入足量冷水
底座正常工作，但壶身加热停止	可能是底座连接器进水导致接触不良	联系售后处理

保修和服务

— 保修和服务说明

- 产品如有明显损坏，请联系BUYDEEM客服中心或送服务点维修。
- 保修仅限生产缺陷及参照说明书正确使用造成的损坏。因使用不当或其他非产品本身质量问题造成的损坏，将收取维修费用。
- 产品超过保修期的客户如需购买产品备件，可联系购买渠道的售后服务中心。

以下情况恕不免费维修：

- 无保修卡或有效发票。
- 未按说明书操作而导致的故障。
- 消费者使用、保管、维护不当造成的损坏。
- 非本公司指定维修部门维修造成的损坏。
- 因不可抗力造成的损坏。

为了客户的利益，BUYDEEM保留对产品特性及组件做出修改的权利，以确保产品的正常使用。

如果您需要更多服务和信息，或有任何疑问，请联系售后服务中心。

保修卡		BUYDEEM	
尊敬的客户， 非常感谢您的购买！该产品提供一年保修。 如果您需要，请在联系我们时准备好以下信息：			
产品型号：		产品名称：	
出厂序列号：		订购日期：	
订单编号：			
客户姓名：		客户电话：	
客户邮箱：			
如果有任何问题或疑虑，请随时给我们发电子邮件。			